

MEMBRANE SEPARATION PROCESSES IN ADVANCED WASTE WATER TREATMENT

H. STRATHMANN

Forschungsinstitut Berghof, 74 Tübingen 1, Berghof, FRG

Abstract—The use of membrane separation processes, especially ultrafiltration, reverse osmosis and electrodialysis, in advanced industrial waste water treatment is described. The problems of adapting membrane processes, which are already established in many industrial and laboratory operations, to the treatment of industrial effluents are discussed. The successful application of membrane separation processes is shown in typical examples.

I. INTRODUCTION

In recent years it has become more and more apparent that conventional waste water treatment processes such as biological conversion, sedimentation, flocculation etc. are often unsatisfactory when large quantities of industrial effluents, which contain large amounts of highly toxic, biologically nondegradable, or high oxygen demanding constituents, have to be treated. Especially in heavy industrialized areas which are in general also densely populated and where surface water is used for domestic water supply, the conventional waste water treatment methods have to be supplemented by more efficient physical or chemical procedures.

Although modern technology has made a large number of sophisticated processes available capable of solving many waste water problems, most have some disadvantage. Rectification or sorption techniques are prohibitively expensive; incineration often causes air pollution problems; and many chemical precipitation processes produce large amounts of sludge the disposal of which can pollute potable water sources.

For many industrial effluents, however, there are procedures available which are not only highly efficient but also economical. These are membrane separation processes, especially reverse osmosis, ultrafiltration and to a lesser extent electrodialysis. During the last decade membrane separation processes have gained increasing publicity and today they are well established and used as standard procedures for many laboratory and industrial mass separation problems.¹ For the treatment of industrial effluents, membrane separation processes offer significant advantages over most other procedures. Waste water constituents, for example, are not destroyed or chemically altered, and valuable products, such as certain metal ions, proteins, or other organic materials can be recovered and commercially utilized. The product water is relatively clean and can often be directly reused with a minimum or no further treatment. By selecting the proper membrane the process can be made highly specific and its costs can be kept relatively low, even for comparatively small size treatment plants.

II. SIGNIFICANT MEMBRANE SEPARATION PROCESSES

Membrane separation processes, which can be successfully used to treat industrial effluents are summarized in Table 1 and their mode of operation is schematically shown in Fig. 1.

By far the most important membrane separation processes for waste water treatment purposes are today ultrafiltration and reverse osmosis, and to a lesser degree

electrodialysis, while dialysis and piezodialysis have virtually no significance as waste water treatment processes.

The differentiation between ultrafiltration and reverse osmosis is rather arbitrary. They are basically identical processes using a hydrostatic pressure gradient as driving force. However, the membrane types used, the areas of application and chemical engineering aspects justify this distinction. With ultrafiltration or reverse osmosis, as in a conventional filtration process, a mixture of different components is brought by convection to a membrane surface and under the driving force of hydrostatic pressure gradients some components permeate the membrane while others are retained more or less completely. Superficially the difference between the processes is only the size of the particles being separated. In conventional filtration only particles larger than a few tenths of a micron in diameter are retained by the filter, in ultrafiltration and reverse osmosis, true molecular solutions can be separated. For macromolecular solutions with solutes having a molecular weight in excess of a few thousand, the process is called ultrafiltration.² The membranes used are microporous in structure, and the separation mechanism is entirely a sieving effect, which separates the different components exclusively according to their molecular dimensions.

If low molecular weight components with similar molecular dimensions are separated the procedure is called reverse osmosis. The membranes used are homogeneous in structure, consisting of a more or less dense polymer layer through which molecules are transported by diffusion. The separation of various components results from specific interaction of the permeating particles with the polymer matrix.³ Since the diffusive transport is comparatively slow, relatively high hydrostatic pressures, up to 100 bar, are used as driving force in reverse osmosis, while in ultrafiltration the operating pressure is 1-10 bar.

Electrodialysis utilizes an electrical potential gradient as driving force and ion exchange membranes as discriminating barrier. Electrodialysis is therefore applicable only for solutions containing ionic constituents. In piezodialysis a hydrostatic pressure is used as driving force and so-called mosaic membranes, which are composed of macroscopic domains of cation- and anionexchange resins. Piezodialysis is again applicable to ionic solution only, and in contrary to reverse osmosis, the ionic constituents are concentrated in the filtrate. In conventional dialysis a concentration gradient is the driving force and the diffusion coefficient the determining

Table 1. Significant membrane separation processes

Separation process	Driving force	Membrane type	Separation mode	Area of application
Ultrafiltration	Hydrostatic pressure 1-10 bar	Asymmetric pore-type membrane	Sieving effect particle radius determining parameter	Separation of macromolecular solutions
Reverse osmosis	Hydrostatic pressure 50-100 bar	Asymmetric solution-diffusion membrane	Determining parameter distribution and diffusion coefficient in the polymer matrix	Separation of solutions with low molecular weight constituents
Electrodialysis	Electric potential	Ionexchange membrane	Electric charges of ions	Separation of salt solutions
Piezodialysis	Hydrostatic pressure 50-100 bar	Mosaic membrane	Electric charges of ions	Concentration of ionic solutions
Dialysis	Concentration gradient	Porous membrane	Diffusion coefficient	Desalting of macromolecular solutions

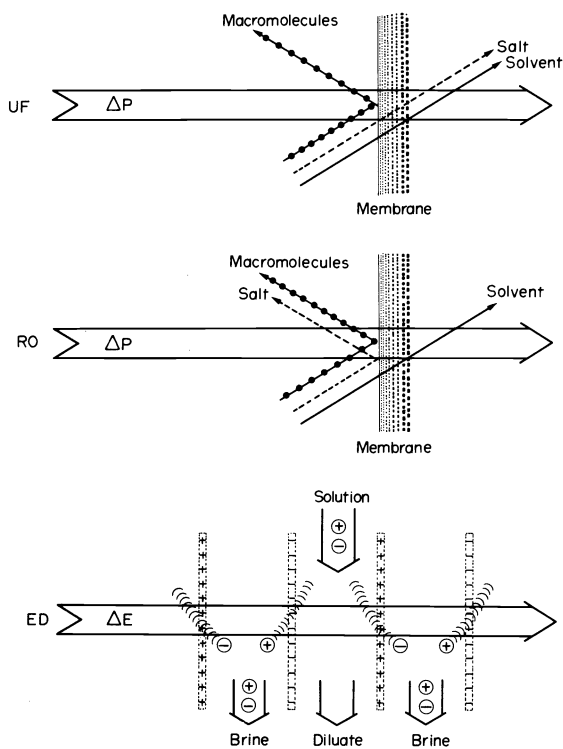

Fig. 1. Schematic diagram of significant industrial membrane separation processes.

parameter for the separation process. Piezodialysis as well as dialysis have today no significance as waste water treatment processes and shall not further be discussed during this outline.

III. PROBLEMS RELATED TO THE USE OF MEMBRANE SEPARATION PROCESSES IN WASTE WATER TREATMENT

Membrane separation techniques first were developed with specific separation problems in mind. Reverse osmosis and electrodialysis were originally developed for water desalination, and ultrafiltration was first applied

in the chemical, biochemical, and pharmaceutical laboratories to concentrate, fractionate, and purify macromolecular solutions. To adjust these processes to the treatment of industrial effluents, significant changes in the membrane properties as well as in the chemical engineering aspects of the process itself are required. For water desalination by reverse osmosis, the "skin type" asymmetric cellulose acetate membrane has proved itself to be very useful, because of its intrinsic properties of high water and low salt sorption. For many industrial effluents cellulose acetate is completely unsuited because of its poor chemical, thermal and mechanical stability. Hollow fiber membranes made from an aromatic polyamid are again successfully used for water desalination. Hollow fiber membranes have significant advantages because of compact construction and low manufacturing cost. The membrane material itself has excellent chemical and thermal stability. However, when effluents with a high content of particulate matters are processed, this system design is severely effected by concentration polarization and therefore not suited for most industrial effluents. Fortunately a whole series of membranes with different filtration properties made from many different basic polymers with excellent chemical and thermal properties are available today, and selection of the proper membrane system allows an optimal control of membrane fouling and concentration polarization.

However, not only the membrane separation procedures have to be modified to satisfy the specific requirements of the industrial effluents, the general waste water treatment philosophy has to be adjusted to the membrane separation process, too. In conventional waste water treatment many different waste streams are collected in a centralized plant, since a high dilution of the various pollutants is desirable. In membrane separation processes, the pollutants are separated mechanically from the water and concentrated and if of commercial value they can be recovered. Membrane processes are highly specific and therefore most efficient when applied to single source effluents, which contain only a few and well defined components in relatively high concentration. For this reason decentralized treatment is most effective. The schematic flow diagram in Fig. 2 indicates the waste water

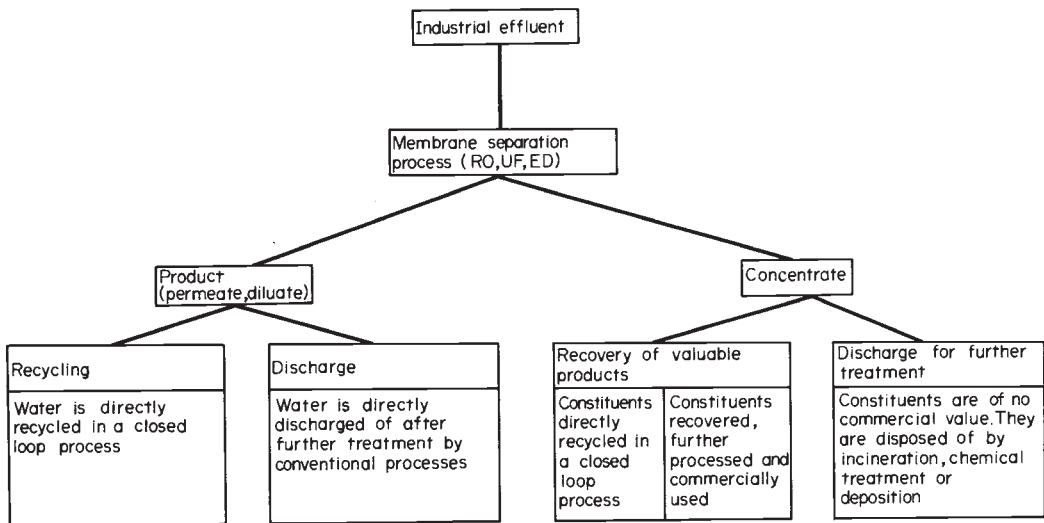

Fig. 2. Schematic flow diagram of waste water treatment by membrane separation processes.

treatment procedure by membrane separation processes. When an industrial waste stream is treated by a membrane separation process, a permeate or diluate, and a concentrate are obtained. Under favorable conditions the permeate contains relatively clean water, which can either be recycled in a closed loop process, or discharged directly or after further treatment in a conventional waste treatment plant. The concentrate contains all pollutants which are either directly recycled in an industrial process or if they contain constituents of commercial value the valuable products are recovered by consecutive procedures such as evaporation, electrolysis, chemical treatment etc. If the pollutants are of no commercial value but highly toxic, they have to be inactivated, destroyed, or precipitated for disposal. Complete recycling of product water and waste water constituents or the recovery of valuable products is from an economical point of view, of course the most desirable process. This can in general be achieved only when single source effluents are treated which are fairly simple and well defined in their composition.

In our laboratory, ultrafiltration, reverse osmosis, and electro dialysis have been applied to a whole series of

industrial waste streams to study the use of membrane separation processes in cleaning industrial effluents. On a laboratory scale most of these waste streams could successfully be handled. Pilot plant tests, however, soon brought up a series of problems. In many cases the chemical or thermal stability of the membrane material was insufficient and useful life of the membrane was rather limited in the environment of many industrial effluents. Even more severe was the problem of concentration polarization and fouling. Especially in ultrafiltration, membrane fouling and the formation of secondary layers on the membrane surface, which often governed the membrane filtration rate completely, could not be avoided. Frequent washing and cleaning cycles had to be introduced to keep the process effective. A scanning electron micrograph in Fig. 3 shows the precipitation on the surface of a capillary ultrafiltration membrane, which was used to filter papermill effluents. Extensive studies of concentration polarization, their causes and consequences are described in the literature.⁴ Concentration polarization effects the efficiency of any separation process, in ultrafiltration of many industrial effluents, however, its consequences are particularly disastrous.

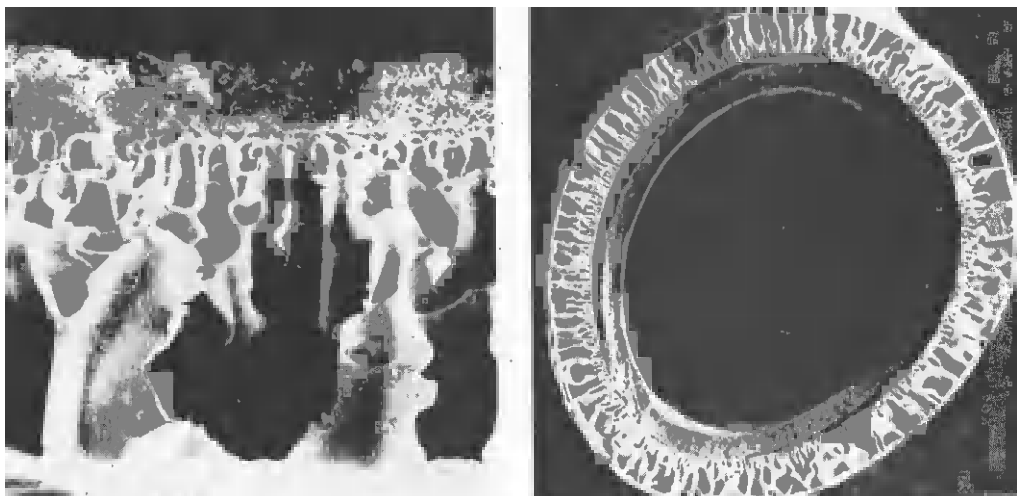

Fig. 3. Scanning electron micrograph showing precipitation on the surface of a capillary ultrafiltration membrane.

The schematic diagram in Fig. 4. illustrates the phenomenon of concentration polarization and membrane fouling. A feed solution containing water and various macromolecular constituents and particulate matters is brought to the membrane surface by convection. While water permeates the membrane under the driving force of a hydrostatic pressure gradient, the dissolved or dispersed constituents are accumulated at the membrane surface and have to be brought back into the bulk solution by diffusion or convection. In ultrafiltration the solubility of the solutes at the membrane feed solution interface is very often exceeded and precipitation is obtained. The precipitated layer itself then acts as a membrane altering the separation characteristics of the original membrane and decreasing water permeability. The water flux through a membrane with a precipitation layer on its surface is given by the following relation:

$$J_v = \frac{1}{R_m + r_p Y_p} \Delta P$$

J_v is the filtration rate, R_m is the hydrodynamic resistance of the membrane, r_p is the specific resistance of the precipitated layer and Y_p its thickness, and ΔP is the hydrostatic pressure driving force. The specific hydrodynamic resistance can reach very high values, when, for example, certain oil emulsions are processed. In high concentration, many oil emulsions tend to form thin oil films on the membrane surface, which are virtually

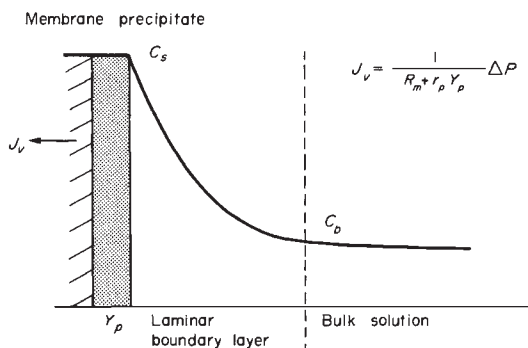

Fig. 4. Schematic diagram illustrating the causes and consequences of concentration polarization and membrane fouling in ultrafiltration of macromolecular solutions.

impermeable to water. In most cases, however, the specific hydrodynamic resistance of a precipitated layer is not as high as that of an oil film, and by controlling the thickness of the boundary layer the effect of membrane fouling can be minimized. The boundary layer thickness is mainly determined by the flow distribution at the membrane surface, which is again governed to a large extent by the system design. For processing industrial effluents which contain high concentrations of macromolecular or dispersed materials, only membrane system designs with an optimal flow control can be used effectively. But even if optimal flow distribution on the membrane surface is achieved, frequent washing cycles are often necessary to remove the precipitated layer. The membrane cleaning procedures with various detergents, and sometimes in tubular membrane systems with rubber foam balls, are rather difficult, and they have to be adjusted to each individual application. The scanning electron micrograph in Fig. 5 shows the precipitation on the surface of a capillary membrane before and after cleaning. The graph in Fig. 6 shows the flux rate of this capillary membrane which was used to process effluents of an instant coffee production. The change in flux due to the cleaning procedure with a hot alkali detergent, which was carried out once every 24 hr for 15 min, can clearly be recognized. It is difficult, however, to give a general procedure for the cleaning process and the composition of the washing solution to be used. This has to be adapted to each effluent to be treated.

IV. INDUSTRIAL EFFLUENTS TREATED BY MEMBRANE SEPARATION PROCESSES

Table 2 summarizes the industrial effluents which can currently be successfully treated by membrane separation processes. Complete recycling of a waste water stream is possible, for example, by applying ultrafiltration to electrophoretic paint effluents. Metal parts which are coated by emersion into an electrophoretic paint bath are rinsed with deionized water to remove excess paint. The rinsing water, containing generally a fraction of a per cent of paint, can be processed by ultrafiltration. The concentrated bleed solution is fed back to the electrophoretic paint bath, and paint filtrate is used directly, or after a minimum of further treatment as rinsing water so that a complete closed loop is achieved. This process is well established today in the automobile industry. Complete

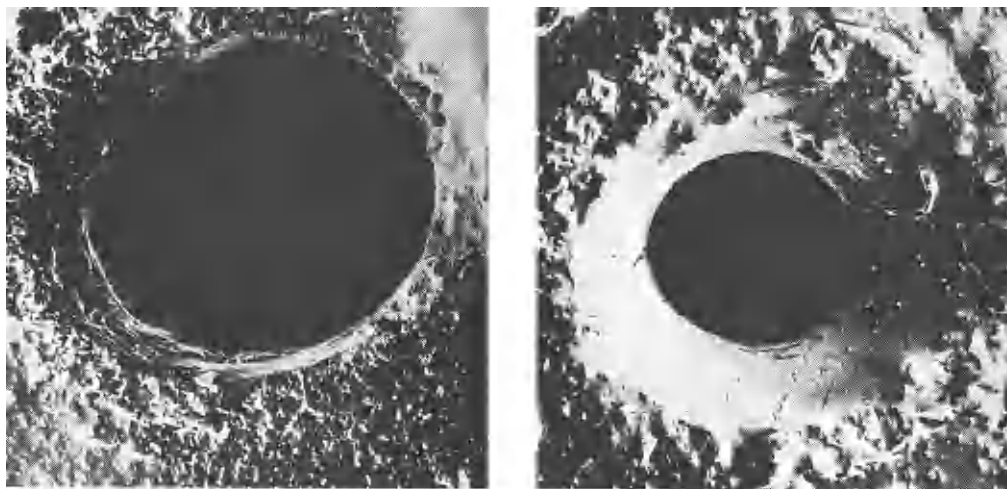

Fig. 5. Scanning electron micrograph of a capillary membrane with precipitation before and after cleaning.

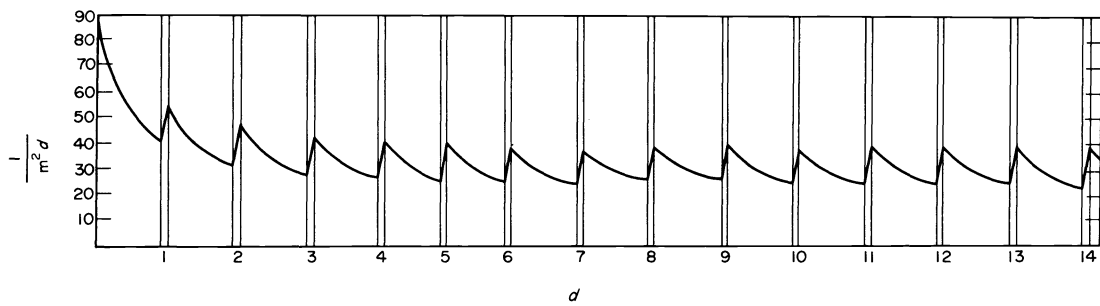

Fig. 6. Filtration rate of a capillary membrane system processing effluents of an instant coffee production as a function of operating time.

Table 2. Industrial effluents which can be treated by membrane separation processes

	Membrane separation process		
	UF	RO	ED
Effluents which can completely be recycled	Waste waters containing oil emulsions, electrophoretic paints, wash solutions from metal washing industries; pigment dyes and latex solutions from textile industries	Waste waters from electroplating and textile industries	Waste waters from electroplating industries
Effluents from which valuable products can be recovered	Waste waters containing proteins as obtained from dairy, meat and fish industries, or breweries	Waste waters from the electroplating and certain food industries	Waste waters from electroplating industries
Effluents with toxic or not biodegradable constituents of no commercial value	Waste waters of the paper, textile and chemical industries	Waste waters of the chemical, electro-chemical and pharmaceutical industries	Waste waters of the chemical and electro-chemical industries

recycling is also possible by ultrafiltration of certain wash solutions used to remove excess oil or oil emulsions from metal parts. The concentrated bleed solution can be directly reused in metal cutting, drawing, or drilling processes, and the oil free filtrate is reused for washing. Complete and direct recycling by ultrafiltration is also possible for certain effluents from the textile industry containing pigment dyes, latex, or other suspended or macromolecular components.

By applying reverse osmosis to rinsing waters of the electroplating industry, complete recycling can be achieved in many cases. Metal parts which have been electroplated are rinsed to remove excess solution carried out of the bath. The rinsing water contains heavy metals such as copper, chromium, zinc etc. which are often very toxic in a relatively low concentration. By reverse osmosis, or electro dialysis, the metal ions can be concentrated to such a level that it can directly be reused in the plating process, while the filtrate or diluate respectively is used again as rinsing fluid.

Valuable products can be recovered from many industrial waste streams especially from the food and drug industry. Here again ultrafiltration is the most widely used process to recover for example proteins from cheese whey, or from effluents or breweries, or the fish and meat processing industry, lanolin is recovered from the effluents of wool washing procedures, enzymes and many other valuable macromolecular constituents are reco-

vered by ultrafiltration from many effluents of the chemical and pharmaceutical industry. Reverse osmosis and electro dialysis is used to treat dairy, sugar and starch industry waste streams and recover valuable products. Certain waste streams from the paper and pulp industry, the textile, the semiconductor, the chemical and pharmaceutical industry containing toxic or nonbiodegradable constituents, which cannot be reused, have successfully been treated by ultrafiltration, reverse osmosis or electro dialysis.

V. SPECIFIC EXAMPLES OF MEMBRANE SEPARATION PROCESSES SUCCESSFULLY APPLIED TO INDUSTRIAL EFFLUENTS

1. Complete recycling of oil emulsion effluents from a metal can production line by ultrafiltration

An oil in water emulsion containing 10 wt% oil is used as lubricating and cooling fluid for a drawing process involving single metal sheets. After the drawing process, excess oil emulsion is removed from the cans in a three stage, 60°C water washing cycle. The rinsing water of a single production line accumulates to about 5 m³/day and contains about 0.6 g/l of oil. The rinsing water is processed in an ultrafiltration unit equipped with 18 capillary membrane modules providing a total of 18 m² of membrane area. In this process the oil is concentrated from about 0.6 g/l to about 100 g/l and without further treatment recycled into the production line. The virtually oil free filtrate is fed directly back into the washing cycle.

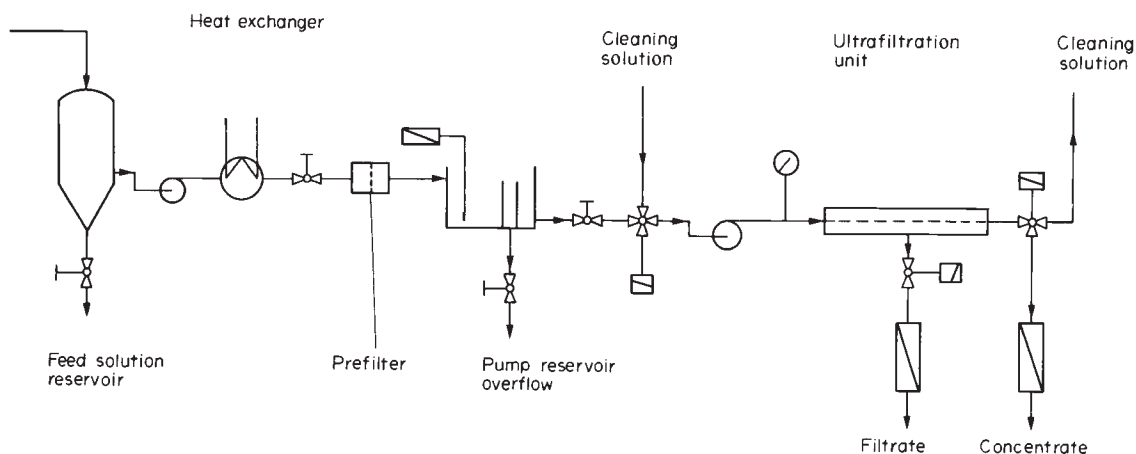

Fig. 7. Flow diagram of an ultrafiltration unit in a closed loop oil emulsion recovery process.

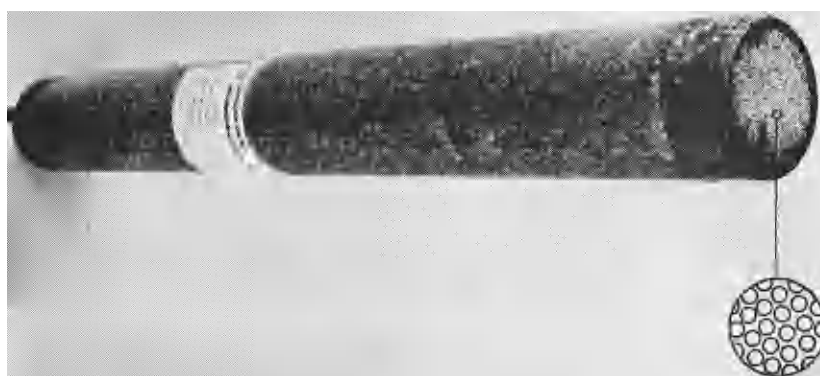

Fig. 8. Photograph of a capillary membrane module containing 1 m^2 of membrane area.

The flow diagram in Fig. 7 illustrates the operation of the unit. Figure 8 shows a capillary membrane module which provides a membrane area of *ca.* 1 m^2 . The operating pressure is 2 bar and the filtration rate with the oil emulsion is $500 \text{ l/m}^2\text{day}$. In Fig. 9 a scanning electron micrograph of the capillary membrane used in this process, is shown. It has an inner diameter of *ca.* 1.2 mm and a maximum operating pressure of 5 bar. The photograph in Fig. 10 shows the actual ultrafiltration unit. In this case not only a severe waste water problem was solved but the complete recycling of water and oil emulsion achieved considerable savings.

2. Removal of mercury from an industrial effluent by diafiltration and a macromolecular complex

This application demonstrates that membrane separation processes can be highly specific. In a laboratory unit the effluent of a chloralkaline electrolysis containing among various other components, 2–5 ppm of mercury, was treated by diafiltration. The mercury waste water was fed into a reactor vessel containing a 10% solution of a macromolecular complexing agent, highly specific for ionic mercury, which can be loaded to about 20 wt % with mercury. In a diafiltration process, which is shown schematically in Fig. 11, the complexed solution is filtered through a capillary membrane unit, which has a molecular weight cut-off of about 30,000. The macromolecular mercury complex is rejected by the membrane while water and all constituents with a molecular weight of less than 30,000 permeate the membrane. The macromolecular complex is fed back into the reactor vessel or discharged,

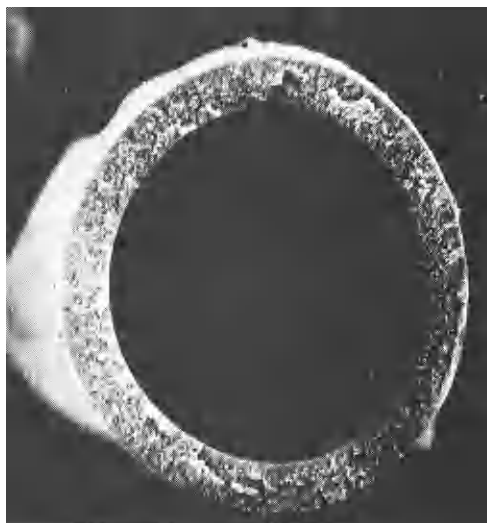

Fig. 9. Scanning electron micrograph of a capillary membrane with an internal diameter of 1.2 mm.

when it is loaded to more than 20% by weight with mercury. The concentration of mercury in the filtrate was less than 1 ppb. The macromolecular complex used in this case reacted specifically with mercury. There is a whole series of water soluble macromolecular complexing agents available, which are specific for other heavy metal ions or groups of ions such as silver, gold, platinum etc.

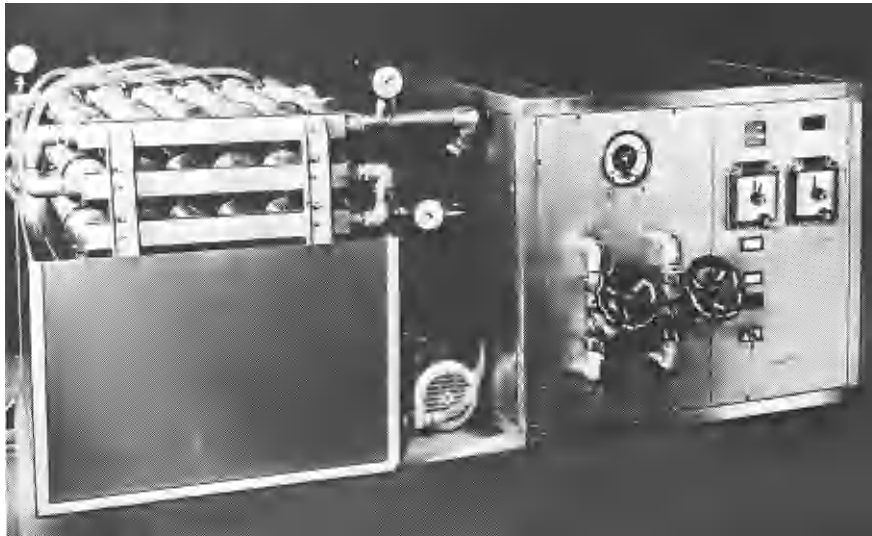

Fig. 10. Photograph of the 18 m² capillary ultrafiltration unit.

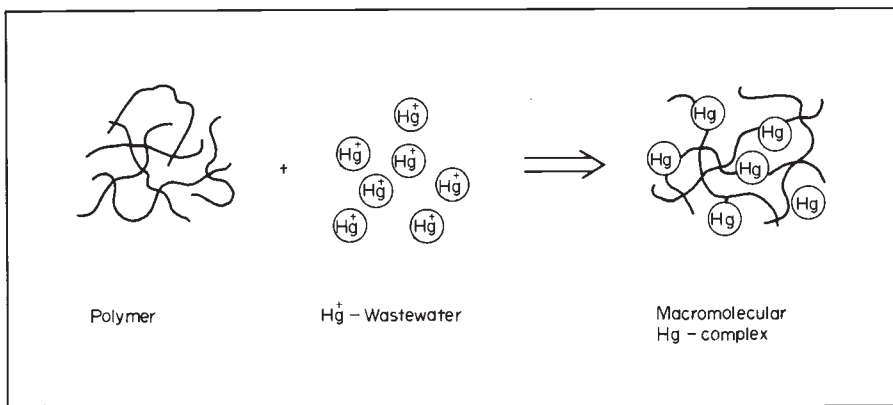
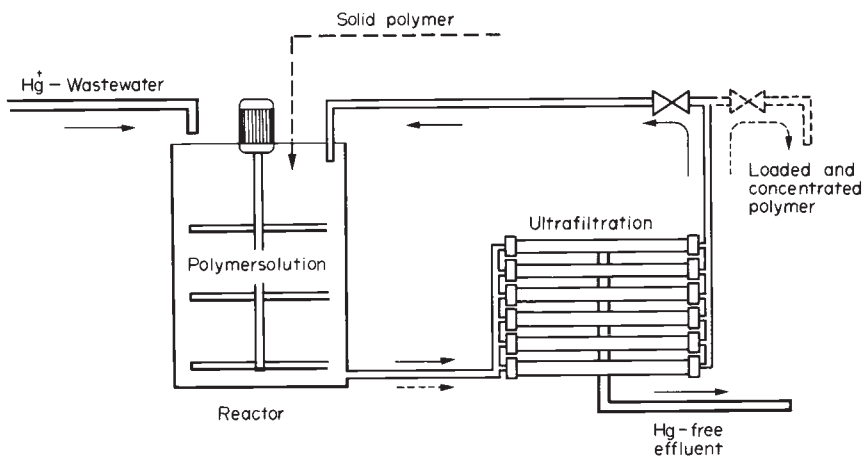

Fig. 11. Schematic diagram illustrating the removal of mercury from an industrial waste stream by diafiltration and a macromolecular complex.

The above described diafiltration procedure for treating industrial waste streams can therefore be applied to extract specific valuable metal ions even when mixed with other substances.

3. Regeneration of a chromium plating bath by electro-dialysis

To improve the surface properties of zinc plated metal parts they are immersed for a certain time in a chromium

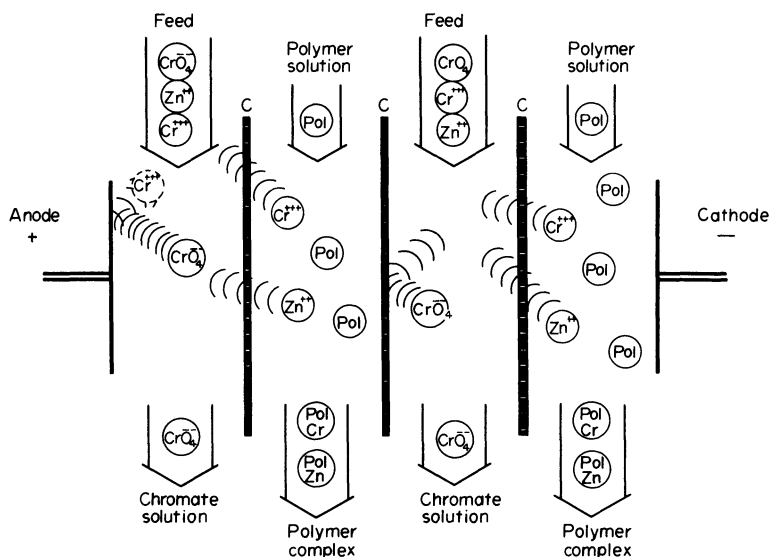

Fig. 12. Schematic diagram of an electrodiolysis process used to generate chromium plating baths.

bath of about 1% chromate. During this process a small amount of zinc is dissolved from the surface and Cr^{6+} is reduced to Cr^{3+} . If the Cr^{3+} and Zn^{2+} ions exceed 2–6 g/l the chromium bath becomes ineffective and has to be discarded. The bath can be regenerated, however, by an electrodiolysis process schematically shown in Fig. 12. In this procedure the Cr^{3+} ions and the Zn^{2+} ions are separated from the CrO_4^- ions by electrodiolysis and the Zn^{2+} ions from a solution by a specific macromolecular complex.

The three examples of the successful use of membrane separation processes in advanced waste water treatment given in this outline indicate the large spectrum of future application. They also show quite clearly that membrane processes can most effectively be used in the treatment of single source effluents containing valuable constituents, which can be recovered or toxic materials which cannot be handled by conventional waste water treatment proce-

dures. For large quantities of multi sources effluents, as obtained from domestic waste streams, membrane separation processes will in the near future not be a replacement of the biological treatment. The use of membranes in advanced waste water treatment will certainly be expanded over the next decade, but for economical considerations it will be limited to process streams which contain recoverable valuable products or constituents which cannot be handled by conventional processes.

REFERENCES

- ¹R. E. Lacey and S. Loeb, *Industrial Processing with Membranes*. Wiley-Interscience, New York.
- ²A. S. Michaels, in *Advances in Separation and Purification*. (Edited by E. S. Perry) John Wiley, New York (1968).
- ³H. K. Lonsdale, in *Desalination by Reverse Osmosis*. (Edited by U. Merten) M.I.T. Press, Cambridge, Mass. (1966).
- ⁴H. Strathmann, *Chem.-Ing.-Tech.* **44**, 1160 (1972); **45**, 825 (1973).