

LIGHT-INDUCED CONFORMATIONAL CHANGES IN CHIRAL POLYMERS WITH PHOTOCROMIC  
SIDE CHAINS

Francesco Ciardelli\*, Carlo Carlini\*, Roberto Solaro\*, Angelina Altomare\*,  
Osvaldo Pieroni<sup>†</sup>, Julien L. Houben<sup>†</sup>, Adriano Fissi<sup>†</sup>

\*Centro di Studio del C.N.R. per le Macromolecole Stereordinate ed Otticamente Attive, Istituto di Chimica Organica Industriale, Università di Pisa,  
<sup>†</sup>Istituto di Biofisica del C.N.R., Pisa, Italy

Abstract - Optically active polymers with hydrocarbon and peptide backbone, bearing photoisomerizable azobenzene and stilbene groups in the side chains, have been prepared by both copolymerization and chemical modification of preformed polymers. The photochromic behaviour and the conformation in solution have been investigated by means of UV absorption, fluorescence and circular dichroism techniques. In copolymers of (-)-menthyl acrylate with 4-acryloxystilbene, 4-vinylstilbene, and 4-acryloxyazobenzene, only indirect evidences of photoinduced conformational rearrangement of the macromolecules were obtained. In analogous photochromic polypeptides, on the other hand, chiroptical properties unequivocally demonstrated that order-disorder conformational variations can be produced by light irradiation, or reversibly, by dark adaptation.

INTRODUCTION

Light irradiation of polymers containing photochromic groups which isomerize and change their shape by absorption of light, may produce conformational changes of the whole macromolecule (secondary and tertiary structure). These effects are well known in biology and can explain the effect of light in many biological processes (1) but have been observed also in synthetic polymers both in solution (2) and solid state (3). Light irradiation however can give rise to a substantial increase of the local temperature which in turn can also be responsible of conformational transitions of the system, particularly in the solid state (3,4).

In order to isolate conformational changes arising only from photochemical effects we have studied photochromic polymers in very dilute solution by chiroptical techniques, in particular CD. Thus we have prepared optically active polymers having either hydrocarbon or peptide backbone with photochromic chromophores, such as azobenzene or stilbene, in the side chain and the changes of chiroptical properties on irradiation have been related to definite conformational transitions involving the secondary structure of chain sections containing the photochromic groups.

POLYMERS WITH HYDROCARBON BACKBONE

Synthesis

The preparation of optically active polymers with hydrocarbon backbone and photochromic side chains has been successfully carried out by the well known copolymerization method (5). This is based on the copolymerization of a ready available optically active monomer, having high enantiomeric purity, with an unsaturated derivative of a photochromic molecule. This section is dealing with macromolecules obtained from (-)-menthyl acrylate (MtA), as the sole optically active monomer, and *trans*-4-acryloxystilbene (AS) (6), *trans*-4-vinylstilbene (VS) (7) and *trans*-4-acryloxyazobenzene (AAB) (8) as photochromic monomers.

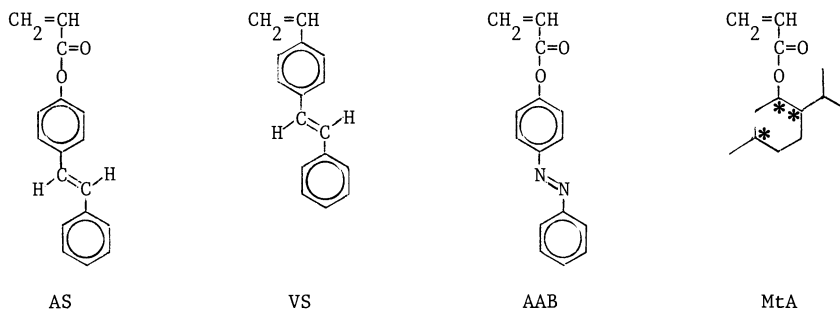

The copolymerizations were performed by a free radical mechanism with AIBN as initiator; the spectroscopic analysis of the polymeric product indicated that no isomerization of the *trans* double bond occurred during the polymerization (6-8). Products solubility, as compared to the corresponding homopolymers, and their chiroptical properties discussed later on, unequivocally proved the formation of copolymer macromolecules. Reactivity ratios have been also evaluated (Table 1); their values suggest a substantially random sequence distribution for the systems MtA/AS and MtA/VS, whereas MtA and AAB show a certain tendency to alternating distribution. In all cases the reactivity ratio corresponding to the photochromic monomer is larger than that of MtA indicating a larger probability of homopropagation.

TABLE 1. Reactivity ratios of (-)-menthyl acrylate ( $M_1$ ) with stilbene and azobenzene containing monomers ( $M_2$ )

$M_1$	$M_2$	$r_1$	$r_2$	$r_1 \cdot r_2$
MtA	AS	0.59	2.38	1.40
MtA	VS	0.36	5.50	1.98
MtA	AAB	0.53	0.89	0.47

#### Photochromic behaviour

Stilbene and azobenzene chromophores are characterized by typical absorption features related with their structure. UV absorption spectra in  $\text{CHCl}_3$  of copolymers of MtA both with AS and VS show the typical broad structured band with two relative maxima at 300 and 312.5-313.5 nm and two shoulders at 288-290 and 325-328 nm. The analogous band has been assigned for *trans*-stilbene to the first  $\pi \rightarrow \pi^*$  electronic transition (9). Hypochromism of the band is observed in the copolymers with increasing the content of AS or VS units, thus suggesting the occurrence of electronic interactions between neighbouring chromophores (10,11).

Upon irradiation in the band of first  $\pi \rightarrow \pi^*$  electronic transition the stilbene groups undergo *trans*→*cis* photoisomerization (Scheme 1) until a photostationary state is reached. Photoisomerization of low-molecular weight model compounds, such as 4-hydroxystilbene 2-methylpropanoate (SP) and 4-methylstilbene (MS), follows a first order kinetics and an isosbestic point (at about 267 nm) can be detected in the UV absorption spectra, indicating that only *cis* and *trans*

SCHEME 1. Photoisomerization of side chains stilbene chromophores.

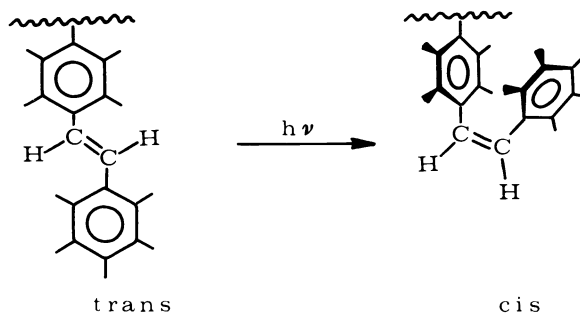

species are present. Detection of an isosbestic point is more difficult in copolymers particularly with increasing the content of stilbene units and secondary photochemical products are probably formed on prolonged irradiation. A progressive deviation from first order kinetics is also observed (7,12).

Fluorescence emission spectra of monomeric analogs SP and MS do not change shape on irradiation, while emission intensity linearly decreases with decreasing absorbance according to the negligible quantum yield of the *cis* form. A non-linear dependence is observed in the copolymers, where on irradiation an increasing fraction of excited AS or VS units cannot populate excimeric sites due to the decrease of exciton migration efficiency and of the probability of having two neighbouring *trans*-stilbene chromophores in suitable orientation. The decrease of exciton migration efficiency is also supported by the monotonic increase with irradiation time of the degree of fluorescence polarization, which is independent of the *trans/cis* ratio in the low molecular weight models.

The copolymers of *trans*-4-acryloylazobenzene (AAB) with (-)M<sub>t</sub>A show in their UV spectra two absorption bands centered at about 420 and 320 nm, attributed to  $n \rightarrow \pi^*$  and  $\pi \rightarrow \pi^*$  transitions of azobenzene, respectively (9). Again with increasing AAB units content bathochromic and ipsochromic effects are observed with respect to the low molecular weight model *trans*-4-(2-methylpropanoyl)azobenzene (IAB), but no signal of aromatic protons attributable to interacting chromophores is present in the <sup>1</sup>H-NMR spectra.

Upon irradiation in the  $\pi \rightarrow \pi^*$  electronic transition *trans*→*cis* isomerization of the azo double bond occurs according to a first order kinetics. Contrarily to the case of stilbene derivative, reverse *cis* to *trans* isomerization can be induced under mild conditions both thermally and by irradiation in the  $n \rightarrow \pi^*$  absorption band.

#### Chiroptical properties of *trans* polymers

Marked differences are observed in the CD spectra of copolymers containing *trans* AS or VS units. Indeed the copolymers of (-)M<sub>t</sub>A with the former monomer show a structured negative dichroic band between 345 and 270 nm the intensity of which increases in absolute value with increasing the content of the optically active units (Fig. 1); this suggests that the highest dissymmetric perturbation of *trans*-AS is obtained when substantially isolated units are flanked by blocks of M<sub>t</sub>A counts. UV absorption spectra and <sup>1</sup>H-NMR spectra suggest interactions between adjacent *trans*-stilbene chromophores. This is furtherly confirmed by fluorescence emission measurements showing that copolymers with more than 30% of *trans* AS or VS units di-

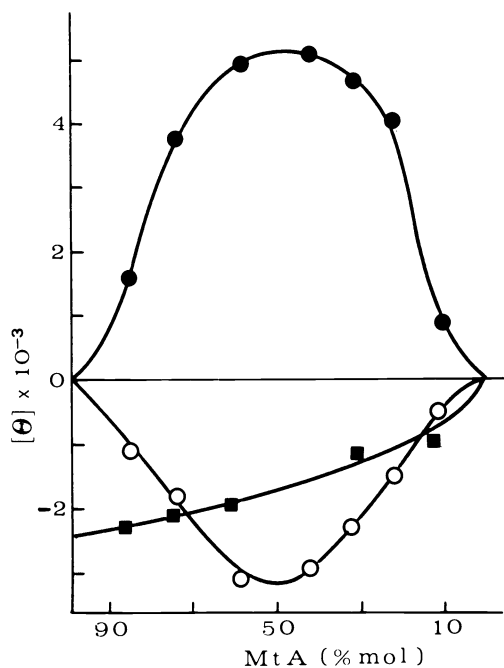

Fig. 1. Variation with composition of CD bands at ■ 313 nm, ● 320 nm, and ○ 280 nm in copolymers of M<sub>t</sub>A with AS (squares) and VS (circles).

splay a long-wavelength emission whose intensity increases with *trans*-stilbene chromophore content. The most obvious interpretation of this result is the formation of excimers, which increasingly contribute to emission spectra with increasing stilbene units content. In addition distortion of vibration modes of aromatic units aligned in sequences could at least in part be responsible for the new longer wavelength emission band. Thus a contribution to CD from dipole-dipole coupling of neighbouring aromatic groups cannot be excluded, but should be substantially weak.

Copolymers containing *trans* VS units show in the same region a couplet with the positive maximum centered at 320 nm and the negative minimum at 280 nm. In this case the largest absolute value of ellipticity in both bands is observed for about 50% mol VS units. Both the couplet and the dependence of its intensity on composition are consistent with the occurrence of dipole-dipole electrostatic interactions between *trans*-stilbene chromophores disposed along chain sections with a predominant skew sense. Certainly the probably not very high stereoregularity of the polymers suggests that this is true only for limited sections of the whole macromolecule. The presence of such dissymmetric conformations involving sequences of *trans*-VS units is furtherly confirmed by the optical rotatory power which does not linearly depend on composition and markedly differs from that of homopolymers mixture. Such a difference is positive and a maximum is again reached for 50% mol VS units (Table 2), according to a dissymmetric disposition of these last in their sequences, as observed for copolymers of trityl methacrylate with (-)- $\alpha$ -methylbenzyl methacrylate (13).

TABLE 2. Optical rotatory power of Mta/Vs copolymers and of the corresponding homopolymers mixtures

% VS	COPOLYMER $[\alpha]_D^{25a)}$	MIXTURES $[\alpha]_D^{25a)}$	DIFFERENCE $\Delta \alpha $
89.5	+ 0.6	- 8.2	+ 8.8
78.5	+ 1.0	- 16.8	+ 17.7
67.5	- 2.3	- 25.4	+ 23.1
57.8	- 7.5	- 32.9	+ 25.4
41.0	- 23.4	- 45.9	+ 22.5
26.0	- 42.5	- 57.4	+ 14.9
14.9	- 58.6	- 65.8	+ 7.2

a) In chloroform,  $\ell = 1$  dm

*Trans* AAB/MtA copolymers display negative optical rotation at 589 nm, which linearly depends on composition as for copolymers of AS with MtA and contrarily to the corresponding VS copolymers. However two dichroic bands at 430 and 300 nm are observed in the absorption region of the azobenzene chromophore. The one at longer wavelength, associated with the  $n \rightarrow \pi^*$  electronic transition, is positive and its ellipticity regularly increases with the content of MtA units. That at shorter wavelength, associated to the  $\pi \rightarrow \pi^*$  electronic transition, shows a very particular behaviour with composition. Indeed it is positive at high contents of AAB units and increases with MtA units up to 45-65%; then decreases and assumes a negative value for the copolymer containing 87.5% MtA units, which corresponds to the highest content examined and where AAB units are practically isolated (8). As no clear evidence exists of dipole-dipole interactions between azobenzene side chains, the positive CD in the  $\pi \rightarrow \pi^*$  band of AAB sequences should be due to substantially dissymmetric chain sections where the single chromophore is optically active because of local site symmetry. The isolated AAB units on the contrary are submitted to the dissymmetric perturbation of (-)MtA units section and give a negative CD. The absence of exciton splitting in samples containing long sequences of AAB units can be explained by considering, as for MtA/AS copolymers, the relative mobility of the side chains with respect to the main chain, which does not allow a sufficient conformational homogeneity (14).

#### Photoregulation of conformation

In spite of the different features of CD spectra for MtA/AS and MtA/Vs copolymers, irradiation produces a drastic decreases of ellipticity (Fig. 2) in all dichroic bands and the small optical activity still detectable at the photostationary state can be attributed to the residual content of *trans*-stilbene moieties. It could be reasonable expected that the conversion from the *trans*-planar form to the non planar *cis* cancels dipole-dipole interactions, as indicated

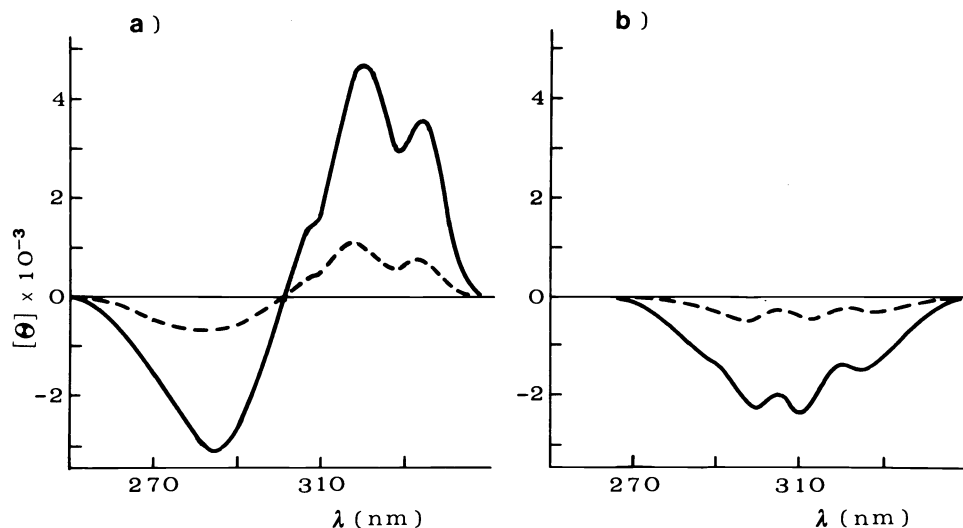

Fig. 2. CD spectra of copolymers of (-)MtA with VS (A) and AS (B) containing about 40% mol of photochromic groups: — all *trans* samples, --- samples at the photostationary state after irradiation at  $\lambda = 330$  nm.

also by emission spectra, and then the corresponding CD bands. Optical activity due to the isolated chromophores should however survive and its disappearance probably means a dramatic change of macromolecular structure with loss of local dissymmetric secondary structure responsible for the chiral perturbation of stilbene chromophores.

Also *trans*→*cis* photoisomerization of azobenzene groups produces substantial changes in chiroptical properties. Thus the copolymers at the photostationary state, when most of AAB units are in the *cis* form, exhibit a broad positive band and a structured negative band corresponding to the  $n \rightarrow \pi^*$  and  $\pi \rightarrow \pi^*$  electronic transitions, respectively. Both bands increase their ellipticity with the content of (-)MtA units. At present is however difficult to say if the CD of the photoisomerized copolymers is due to the azobenzene in the *cis* form or to the residual *trans* groups, which being isolated would give rise to a negative CD band, not partially covered by the positive contribution of blocks from *trans* AAB units. The fact that the photoisomerization is not accompanied by a complete disappearance of dichroic bands associated with the aromatic chromophore, probably indicates that no dramatic change of the chain conformation occurs, or at least the dissymmetric perturbation by the MtA units is still appreciable. As already pointed out this seems to be not true for stilbene containing polymers, in particular when the photochromic group is directly bound to the main chain as in VS. Dark adapted copolymers of AAB give rise to the thermal *cis*→*trans* isomerization which restore the original CD and then the original secondary structure of the macromolecules.

#### POLYMERS WITH PEPTIDE BACKBONE

Polypeptides and poly( $\alpha$ -amino acids) are very particular cases in which chiroptical properties in the spectral absorption region of peptide chromophore can be related unequivocally with the conformation of the macromolecular chains (15). Such relation can be useful also in case of polypeptides with non-transparent side chains, provided the contributions of these last can be separated from those of peptide group.

Poly(L-glutamates) containing stilbene or azobenzene groups in the side chains show strong CD bands at  $\lambda > 250$  nm, whereas the bands associated with the polypeptide main chain are located below this value. It is thus possible to investigate, by CD, polypeptides with the above photochromic side chains, and to obtain reliable information both on the backbone secondary structure and side chain conformational arrangement.

This approach for polypeptides containing aromatic azo groups in the side chains of L-glutamate residues was first attempted by Goodman and Falxa (16), who observed that the photoisomerization of the azo groups was accompanied by changes in optical rotatory dispersion spectra. Conversely, the photochromic properties of the azo-polypeptides were markedly affected by the

conformation of the macromolecules.

More recently Ueno and coworkers (17-21) observed photoinduced conformational changes in copolymers of phenylazobenzyl-L-aspartate and  $\gamma$ -benzyl-L-aspartate. The dark adapted samples showed CD spectra with a positive band at about 220 nm which was attributed to the presence of a left-handed helix. The change in sign of the band after irradiation was then taken as an indication of the photoinduced reversal of the helix sense of the polypeptide chains. The largest effects were obtained in solvent mixtures. In fact, the above copolypeptides are left-handed in pure dichloroethane, while they are right-handed in pure trimethylphosphate (TMP). The inversion occurs between 20 and 50% TMP, however the TMP dependence of the conformation is different for the dark adapted polymer and the irradiated one. So, remarkable effects on CD spectra were observed when irradiation was carried out within the above critical composition (20,21).

In this section we will discuss in more detail the results obtained in our laboratory concerning polymers of L-glutamic acid containing azobenzene or stilbene groups in the side chains. For them, a quite complete picture of the relationship between secondary structure and photochromic behaviour has been recently obtained, thanks to the very good separation between bands associated with peptide and photochromic chromophores, and the well defined relationships between chiroptical properties and secondary structure of poly(L-glutamic acid) and its derivatives (22-25).

### Synthesis

Photochromic polypeptides containing azobenzene or stilbene groups in the side chains were obtained by condensation of poly(L-glutamic acid) with *p*.amino-azobenzene or *p*.amino-stilbene, respectively (Scheme 2). When the modification reactions were carried out in the presence of

SCHEME 2

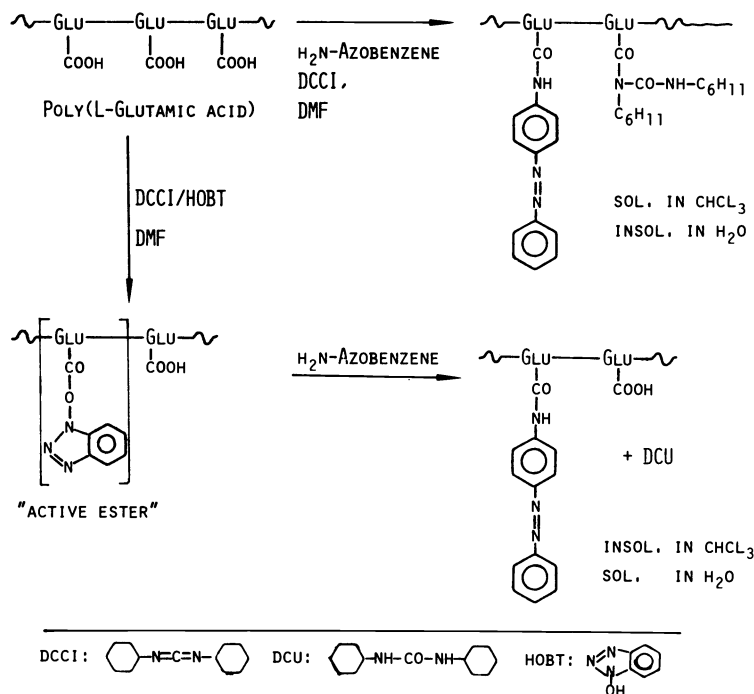

just dicyclohexylcarbodiimide (DCCI), only 7-14% mol of azo groups were introduced in the side chains of the Glu residues, even in the presence of large excess of the azo reagent and with long reaction times (Table 3). The modified polymers were soluble in organic solvents such as chloroform and 1,2-dichloroethane, but insoluble in alkaline water. Elemental analysis and <sup>1</sup>H-NMR spectra have shown that these polymers contain considerable amounts of N-acylureic groups originated by side reaction between DCCI and the  $\gamma$ -carboxylic functions (25). When the modification reactions were carried out in the presence of DCCI and one equivalent of N-hydro-

xy-benzotriazole (HOBT), polymers having high contents of azo groups were obtained, and their solubility properties are quite different from those of the samples prepared in the absence of HOBT (Table 3). As expected, they are soluble also in alkaline water, and spectroscopic data

TABLE 3. Modification of poly(L-glutamic acid) with *p*.amino-azobenzene.

Sample	$\bar{M}_v$	Reaction conditions				azo content, %	soluble in
		Condg reagent	R <sup>a)</sup>	T(°C)	Durn, hr		
1a	5,000	DCCI	1.0	70	16	7	CHCl <sub>3</sub> , DMF
1b	50,000 <sup>b)</sup>	"	2.0	50	16	8	" "
1c	50,000	"	5.0	70	35	14	" "
1d <sup>c)</sup>	60,000	"	2.0	70	96	9	CHCl <sub>3</sub> , TFE, DMF
2a	200,000 <sup>b)</sup>	DCCI/HOBT	3.0	20	5	13	H <sub>2</sub> O, TMP, DMF
2b	"	"	3.0	20	24	36	" " "
2c	"	"	3.0	20	150	52	TMP, DMF
2d	"	"	3.0	50	150	56	" "
3a	200,000 <sup>b)</sup>	PvCl	1.1	0-10	24	16	H <sub>2</sub> O, TMP, DMF
3b	"	"	1.1	0-10	24	21	" " "

a) Azo-reagent/ $\gamma$ -COOH groups molar ratio.

b) After fractionation by gel filtration chromatography on Sephadex G50.

c) 1/1 Copolymer L-glutamic acid/L-glutamic acid  $\gamma$ -methyl ester.

confirm the presence of both free Glu residues and azo-modified Glu residues. Thus it is possible to conclude that contamination by N-acylureic groups was suppressed by addition of HOBT (26), in the presence of which the only reaction occurring was the attachment of *p*.aminoazobenzene to the side carboxyl groups of the polypeptide through formation of the corresponding amide. The same result has been obtained according to an adapted mixed anhydride method, by addition of pivaloyl chloride (PvCl) to poly(L-glutamic acid) in DMF and successive reaction with *p*.aminoazobenzene.

Stilbene containing poly(L-glutamic acid) was prepared by modification of the poly( $\alpha$ -amino acid) with *p*.amino-stilbene hydrochloride in the presence of 1 equivalent of DCCI and HOBT. The modified polymer contained 16% mol stilbene groups and was soluble in TMP as well as in alkaline or weakly acid aqueous solution (24).

Poly(L-aspartic acid) gives, under the above conditions, polymer containing only 1-2% mol of azobenzene groups, and the modification reaction produces large amounts of N-succinimide rings, probably caused by the condensing reagents DCCI or PvCl. Actually, Asp residues can easily undergo cyclization to give five-membered rings (27). Therefore the polymers of this amino acid have not been further investigated.

#### Photochromic behaviour

In TMP, the absorption spectrum of the dark adapted azo-polypeptides (azo groups in *trans* configuration) is characterized by an intense band at 355 nm, associated with the first  $\pi \rightarrow \pi^*$  electronic transition of the azobenzene chromophore, and a weak band at 450 nm associated with the  $n \rightarrow \pi^*$  transition (25). In water, the main absorption band is blue-shifted to 340 nm.

Irradiation at  $\lambda < 380$  nm produces the photo-isomerization into the metastable, non-planar, *cis* configuration, revealed by a strong decrease of the  $\pi \rightarrow \pi^*$  band, and a contemporary increase of the  $n \rightarrow \pi^*$  band. The opposite *cis*-to-*trans* isomerization can be obtained by dark adaptation or irradiation at  $\lambda > 420$  nm.

The relative composition at the photostationary state depends, in both solvents, on the wavelength of the incident light, but not on the light intensity and the initial state of the samples. In TMP, irradiation at  $\lambda = 369$  nm produces about 90% *trans*-to-*cis* photoconversions, whereas in aqueous solution, markedly lower photoconversions are obtained (about 40%). In both solvents, the photochemical reactions are completely reversible, and the photochromic cycles can be nicely repeated with no apparent fatigue.

At room temperature in the dark, stilbene residues are all in *trans* configuration. Irradiation

at 330 nm produces about 85% *trans*-to-*cis* photoconversion both in TMP and in aqueous solution. Other photochemical reactions, such as cyclodimerization into cyclobutane derivatives, or intramolecular cyclization to dehydrophenantrene derivatives, do not seem to occur under the used experimental conditions. The photoisomerization is accompanied by drastic variations of the absorption and fluorescence spectra. Actually, only the *trans* isomer exhibits fluorescence with a peak at 390 nm when excited at 320 nm.

#### Conformation in solution

The chiroptical properties of the two types of azo-modified poly(Glu), soluble or insoluble in chloroform, show remarkable differences and are discussed separately.

First of all it must be pointed out that the low molecular weight compound N-acetyl- $\gamma$ -benzyl-L-glutamate *p*-phenylazo-anilide, where the azo group is bound to the carboxyl group in  $\alpha$ -position with respect to the asymmetric carbon atom, does not show appreciable CD bands between 240 and 550 nm. In this region the azo-polypeptides 1a-1d (Table 3), containing acylureic groups, show in chloroform solution, intense CD bands, the shape of the curves being strongly dependent of the *trans/cis* ratio in the azo-aromatic side chains.

The dark adapted polypeptides (all *trans* chromophores) show a weak positive dichroic band at 450 nm, associated with the  $n \rightarrow \pi^*$  transition of the azo chromophore, and two intense bands, the former positive at 370 nm and the latter negative at 330 nm, due to the splitting of the  $\pi \rightarrow \pi^*$  transition. In the 369 nm irradiated polymers (about 90% *cis* chromophores), the CD band centered at 450 nm is strongly increased with a shoulder at about 370 nm, while at 330 nm an intense negative band is present (22).

The CD spectra give a clear demonstration that, in chloroform, the azo chromophores bound to poly(L-glutamic acid) are optically active, their chiroptical properties depending on configuration around the -N=N- double bond. In the "all-*trans*" polymer, evidence exists that the azo chromophores give dipole-dipole interactions yielding the positive couplet in the region of the  $\pi \rightarrow \pi^*$  electronic transition. In the "substantially *cis*" polymer, no evidence of a couplet is observed. The strong increase of the ellipticity of the CD band associated with the  $n \rightarrow \pi^*$  transition, and the corresponding one for the  $\pi \rightarrow \pi^*$  transition, can be explained on the basis of the inherent dissymmetry of the skewed azobenzene moiety, with a large prevalence of one sense of skew, suggesting dissymmetric interactions with the macromolecular chain in ordered conformation.

A completely different situation is observed in case of the azo-poly(L-glutamates) non-containing acylureic groups, which are soluble in different solvents.

In TMP, dark adapted samples exhibit the typical  $\alpha$ -helix CD pattern, with minima at 222 and 208 nm. The helix content, estimated on the basis of the ellipticity at 222 nm,  $[\theta]_{222}$ , decreases at first with increasing the azo-modified Glu residues, reaching the minimum for a content of 30-36% mol, which corresponds to an average distribution of one azobenzene every helical turn. For higher values of azo contents, the  $\alpha$ -helix content increases again, and for the polypeptide containing 56% mol azo groups, the ellipticity at 222 nm nearly corresponds to the standard value of poly(L-glutamic acid). The behaviour agrees with the general observation that the  $\alpha$ -helix conformation of a co-polypeptide of two amino acid residues is usually less stable than the helix structure of the two corresponding homo-polypeptides. Above 250 nm, an extrinsic couplet is also present, with peaks at 370 and 330 nm respectively, and centered at 350 nm, where the intense  $\pi \rightarrow \pi^*$  electronic transition of the azo chromophore is located. The ellipticity values of these extrinsic CD bands markedly depend on the azo content (Fig. 3).

The *trans*-to-*cis* photoisomerization practically does not modify the CD spectra in the peptide region. By contrast, irradiation completely cancels, in all samples, the extrinsic CD bands above 250 nm. At a fixed azo content, the ellipticity at 370 and 330 nm decreases with decreasing the *trans* azo fraction as a quadratic function (25), confirming their exciton origin as a result of dipole-dipole interactions between *trans* azo side chains.

The typical shape of the  $\alpha$ -helix CD spectra and the lack of variations below 250 nm going from the *trans* to the *cis* form, allow us to conclude that side chain electronic transitions do not give rise to any dichroic bands in the peptide region.

In water, solubility and conformation of azo-modified poly(L-glutamates) markedly depend on chemical composition, as they contemporaneously contain hydrophobic (azobenzene) and hydrophilic (unreacted COOH) side chains. Samples containing more than 36% mol azobenzene groups are not soluble in water. Moreover, aggregation phenomena and precipitation slowly take place,



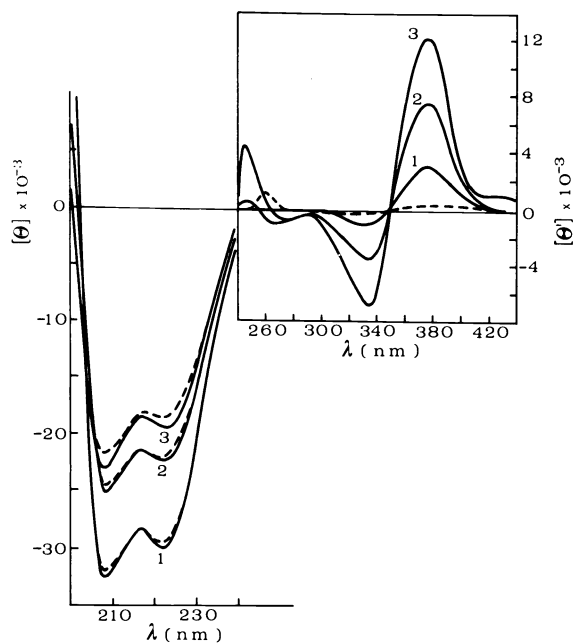

Fig. 3. CD spectra in TMP solution, of azobenzene-containing poly(L-glutamic acid) having various azo contents; 1: 16% mol; 2: 21% mol; 3: 36% mol. (—) Before irradiation; (---) After irradiation.

as often observed in aqueous solutions of polypeptides containing hydrophobic residues (28,29).

At acid pH, the CD spectra of the polypeptides containing 16% and 21% mol azobenzene groups indicate the presence of an appreciable amount of  $\alpha$ -helix, even though the ellipticities are lower than in TMP solution. The helix stability is still rather high in the 16% mol azo-containing polymer (helix content: about 55-60%), but it is much lower (about 25-30%) in the 21% mol azo containing polymer. Finally, the 36% mol azo-containing poly(L-glutamate) shows a CD curve with a single extremum at 220 nm, suggesting loss of  $\alpha$ -helix structure and formation of  $\beta$ -structure. Indeed  $\beta$ -structures are favored in water solution when polypeptides contain comparable amounts of both hydrophobic and hydrophilic amino acid residues (30,31). The conformational modifications occurring in water solutions are also revealed by the change of sign, from positive in TMP to negative in water, of the exciton couplet in the main absorption region of the azo chromophore. The negative couplet is particularly strong when the polymer has a substantially  $\beta$ -structure.

All the dark adapted azo-polypeptides,  $\alpha$ -helical or  $\beta$ -structured in acid pHs, undergo conformational transitions when pH is increased to alkaline values. However, the order-disorder transition curves of these azo containing poly(L-glutamates) are shifted to higher pH values, compared with that of the pure poly(L-glutamic acid), and the pKs are clearly influenced by the content of azobenzene groups. So, the midpoint for the pH-induced transition, which is usually reported to occur at about 5.5 (32) for poly(L-glutamic acid), is observed at pH 6.5, 7.4, and 6.8 for the polypeptides containing respectively 16%, 21%, and 36% mol of azo groups. It must be noted that a  $\alpha$ -coil transition occurs in the first two cases, and a  $\beta$ -coil transition in the last one.

This behaviour can be attributed to the hydrophobic environment provided by *trans* azobenzene side chains around the ionizable COOH groups. It is well known, in fact, that organic solvents with low dielectric constant, added to aqueous solutions of poly(L-glutamic acid), produce a shifting of the pK of the helix-coil transition toward higher values, as a result of a change in the degree of dissociation of the side chain carboxyl groups (32).

In TMP, non-irradiated samples of a stilbene containing poly(L-glutamic acid) (16% mol), display the standard CD spectrum of the  $\alpha$ -helix between 200 and 250 nm, and a couplet centered at 315 nm which can be associated with an exciton splitting of the 326 nm transition of stilbene chromophore. Accordingly, the degree of polarization of the fluorescence is rather low,

indicating exciton migration among stilbene chromophores (33).

When the solutions of dark adapted samples in TMP are diluted with water up to 50%, no appreciable variations of the  $\alpha$ -helix CD pattern occur. Only a slight decrease of the helix content can be observed for water concentrations higher than 50%. On the contrary, the CD bands in the main absorption region of stilbene chromophore (300-350 nm) strongly decrease by increasing water concentration and disappear for water content higher than 50%. In the fluorescence spectrum, addition of water to the TMP solution gives rise to a new band at 450 nm which can be assigned to an excimer species (34).

The above results are in agreement with the presence, in TMP solution, of an ordered arrangement of the side chains, on the periphery of the helical backbone of the polypeptide, stabilized by hydrogen bonding between the  $\gamma$ -COOH or  $\gamma$ -CONH- functions. This side chain secondary structure has been recognized for some time as an important factor in determining the stability of helices (35,36). Water is likely to destroy the side chain secondary structure (disappearance of side chain CD bands) and to promote hydrophobic associations of stilbene groups (appearance of excimer fluorescence band).

#### Photoregulation of conformation

In TMP, light produces efficient isomerization of the azo side chains, but does not induce any variation of the backbone conformation, as shown by the constancy of the CD bands in the peptide absorption region (Fig. 3). By contrast in water, in spite of the lower *trans*-to-*cis* photoconversions, irradiation produces remarkable effects on the CD bands connected with the polypeptide conformation (Figs. 4 and 5).

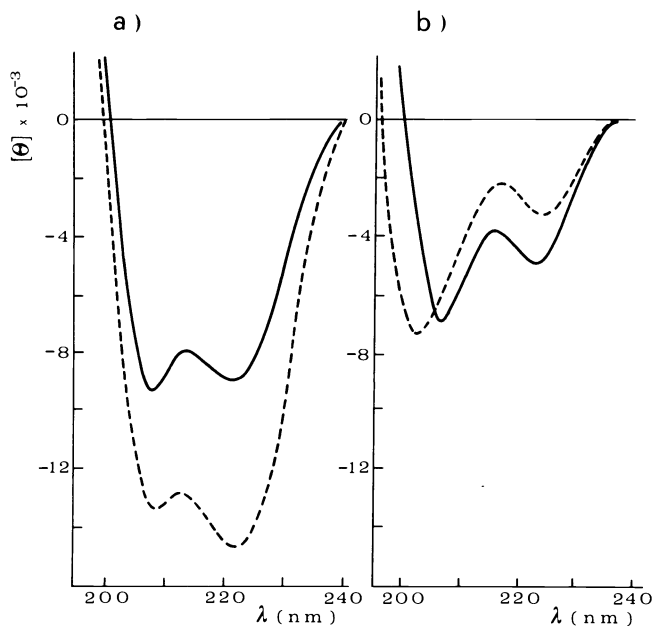

Fig. 4. Poly(L-glutamic acid) containing 21% mol azobenzene groups. CD spectra before (—) and after (---) irradiation at  $\lambda = 369$  nm in aqueous solution. a) pH 5.6; b) pH 7.1.

Like conformation and conformational transitions, also photoinduced effects are influenced by the azo content. Irradiation of the polymer containing 16% mol azo groups does not produce any variation of its conformation. On the contrary, irradiation of the polymers containing 21% and 36% mol azo groups produce remarkable conformational changes.

The conformational behaviour under the effect of light is different at different pH values. In the case of the polymer having 21% mol azo groups, at pH 5.6, light produces a rather strong increase of the CD bands connected with the  $\alpha$ -helix structure (Fig. 4a). The relative increase of the helix content can be estimated to be about 65-70%. At a slightly higher pH value (pH 6.0), irradiation does not induce any variation of the CD spectrum below 250 nm, but between pH 6.0 and pH 8.0, where the helix-coil transition occurs, light causes a moderate decrease of the helix content (Fig. 4b). At pH 8.0, the conformation is completely random

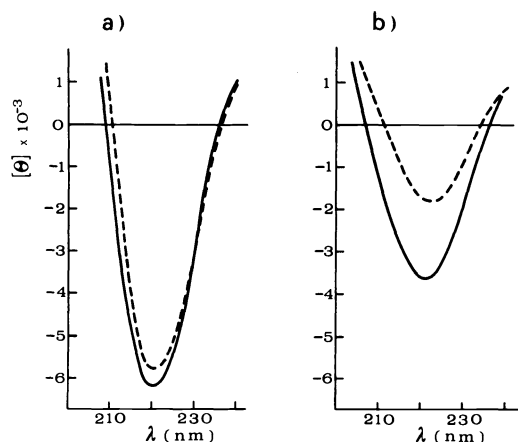

Fig. 5. Poly(L-glutamic acid) containing 36% mol azo groups. CD spectra before (—) and after (---) irradiation. a) pH 4.8; b) pH 6.5.

coil and not affected by irradiation at all. Finally, the polymer containing 36% mol azo groups undergoes a  $\beta$ -coil change, only when irradiation is carried out around the pH of the conformational transition (Fig. 5).

The light-induced effects can be better understood by considering the influence of light on the conformational transition curves (Fig. 6). For the 16% azo-polymer, no difference has been observed in the pK of the helix-coil transition between the dark-adapted sample and the irradiated one. For the other two polypeptides, the pKs of the order-disorder transition of the irradiated samples are shifted toward lower values with respect to the corresponding values of the dark adapted ones. In the case of the 21% azo-polymer, the lower limits of the sigmoidal curves are different for dark adapted and irradiated samples. The phenomenon probably occurs only in polymers having critical azo-content or labile folded structures.

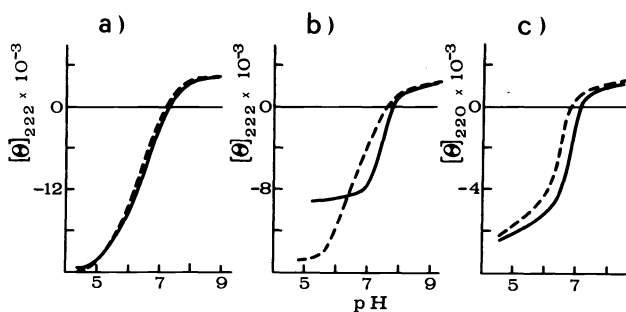

Fig. 6. Minimum ellipticity,  $[\theta]_{222}$  or  $[\theta]_{220}$ , as a function of pH in various dark adapted (—) and irradiated (---) azo-poly(L-glutamates). a) 16% mol; b) 21% mol; c) 36% mol.

During the photoisomerization, the molecular geometry of the azo group changes from the extended planar *trans* configuration to the skewed configuration of the *cis* isomer. In addition, its polarity and hydrophobicity dramatically change, since the *trans* isomer is practically apolar, whereas the *cis* form is characterized by a high dipole moment. So, the *trans*→*cis* isomerization causes a polarity variation of the environment around the polypeptide backbone.

Both the geometry and polarity factors can be the driving forces responsible for the photoreversible effects, and they seem to be operative in two opposite directions. The helix stability decreases with the *trans*-azo content, so the isomerization to the *cis* form can actually determine an increase of the helix content. On the other hand, the higher polarity of the *cis* isomer can produce a higher dissociation degree of the neighbouring COOH groups, which, in turn, is reflected in a partial disruption of the ordered conformation. The first factor seems to be predominant for the 21% azo-polypeptide when irradiating at pH 5.6. The second factor seems to be predominant when the irradiation is carried out at around the ionization pK of the COOH groups.

Also in the case of stilbene-polypeptides, in TMP solution, irradiation at 330 nm (85% *trans*-to-*cis* photoisomerization) completely cancels the CD couplet at 315 nm, without affecting the CD pattern of the  $\alpha$ -helix structure. The typical shape of the  $\alpha$ -helix curve and the lack of any variations going from the *trans* to the *cis* form, allows us to exclude any important contributions of the stilbene chromophores to the optical activity in the peptide region (200-250 nm). Indeed, these contributions, if any, should be different for the *trans* and the *cis* form, as the two isomers are characterized by different electronic transitions. Thus, in TMP light produces the photoisomerization of the side chains, but does not induce any variation of the backbone conformation, probably because of the high stability of the ordered structure under these conditions.

In TMP/water solution, on the other hand, irradiation produces a remarkable decrease of the CD bands connected with the  $\alpha$ -helix (Fig. 7). The light-induced decrease of the helix content can be explained considering the reduced stability of the ordered structure in aqueous solution with respect to the TMP solution.

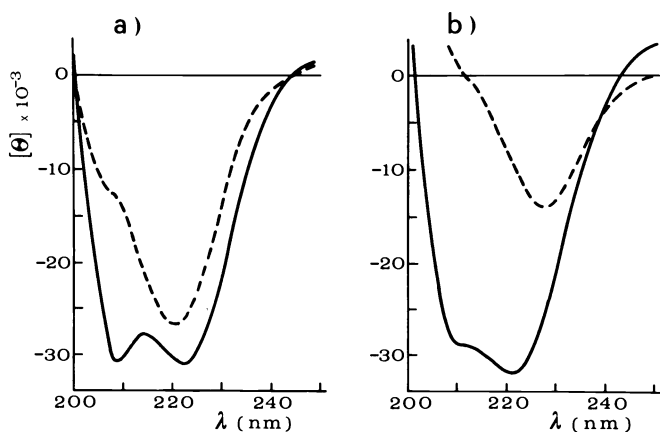

Fig. 7. CD spectra of poly(L-glutamic acid) containing 16% mol stilbene groups, before (—) and after (---) irradiation. a) In TMP/H<sub>2</sub>O = 50/50, neutral solution. b) The same, in the presence of 0.05 M NaCl.

The photoresponsive effect can be enhanced when irradiating the system in the presence of NaCl which also affects the stability of ordered structures in polyelectrolytes and polypeptides (38). In 0.05 M sodium chloride, the relative decrease of the helix content, based on the ellipticity at 222 nm, is about 55%.

#### CONCLUDING REMARKS

The simple free radical copolymerization of *trans*-azobenzene or *trans*-stilbene unsaturated derivatives with an optically active comonomer such as (-)-menthyl acrylate allows to obtain polymeric products showing CD bands in the region of the near UV electronic transitions of the aromatic chromophores. Non-irradiated samples of *trans*-4-vinylstilbene/(-)-menthyl acrylate copolymers, where the stilbene group is directly bound to the main chain, exhibit a strong exciton couplet which decreases in intensity on irradiation and practically disappears at the

photostationary state, when 90% or more stilbene groups are in *cis* configuration.

The CD bands can be attributed to interactions between aromatic nuclei disposed in a rigid conformation with a predominant chirality, and thus having a certain degree of structural order. Their disappearance can be due to conformational changes accompanying the photoisomerization of the photochromic side chains. However, the occurrence of such photoinduced variations can be only argued from the behaviour of the side chain CD bands, as CD bands connected with the structure of main chains are not observed in polymers with paraffinic backbone (39).

These results and their interpretation are substantiated by the parallel investigation carried out on poly(L-glutamic acid) with attached azobenzene or stilbene groups, as peptide chromophore and photochromic groups give well distinct CD patterns. Thus, it is possible to carry out the contemporary investigation of CD spectra both in the peptide and side chain absorption regions, and to obtain meaningful data about the presence of both side chain and main chain secondary structure.

Chromophoric groups, such as aromatic groups, bound to the side chains of helical poly(L-glutamate) exhibit only weak CD bands, especially when a low content of aromatic groups is present (40). An appreciable induced CD of the aromatic chromophore was observed in poly( $\gamma$ -benzyl-L-glutamate), only in highly concentrated solution where the polymer forms cholesteric liquid crystals (41). The formation of a super-helix stabilized by side chain hydrogen bonds is probably responsible for side chains rigidity and their optical activity. Clearly, this super-helix is sensitive to the medium (solvent and pH) as well as to the side chain *trans* or *cis* configuration.

The reported results have allowed to establish that the type and the extent of the photore-sponsiveness depend on the content of azo or stilbene groups and solvent conditions under which irradiation is carried out. The maximum of light-induced effects can be achieved when the system is in a labile fold structure. This can be obtained by irradiation close to conformational transitions of the system employing polypeptides having low conformational stability either due to the presence of critical contents of photoresponsive chromophore or by using a suitable solvent or solvent-mixture.

The primary event responsible for secondary structure changes is the *trans*↔*cis* photoisomerization on the side chain. However, the simple geometry variation during the photoisomerization of the chromophore does not seem to be sufficient to induce appreciable conformational changes of the macromolecule main chain (no effects have been actually observed upon photoisomerization in TMP). At least for the described polypeptides, the driving force of photoregulation is likely to result from a polarity variation on the environment around the polypeptide backbone.

The situation is however different in azobenzene and stilbene containing polymers. In the former case the *trans* and *cis* isomers have different hydrophobicity and, in water, the secondary structure depends on the content and configuration of azobenzene groups, as well as on the ionization degree of the neighbouring COOH groups. The *trans*-to-*cis* photoisomerization could produce a higher ionization degree of the COOH side chain, thus amplifying the first light effect and causing the unfolding of the polypeptide. Accordingly, the pK values for the pH-induced conformational transitions, which may represent also the apparent pKs for the ionization of the COOH group, are lower when the neighbouring azo groups are in *cis* than when they are in *trans* configuration. In the case of stilbene containing polypeptides, in the presence of water, the  $\alpha$ -helix is stabilized by planar *trans* side chain interactions shown by excimer formation. This stabilization is removed by irradiation which isomerizes *trans*-stilbene into the non-planar *cis* form with disappearance of excimer emission. In this case an appreciable (up to 70%) helix-coil transitions takes place.

Even if these results point out clearly the different behaviour of the systems investigated, thus not allowing to make general extrapolation, their convenient use can be reasonably expected both for designing more valid conformationally photoresponsive polymers and for better understanding photoregulated biological process (42).

#### REFERENCES

1. B.F.Erlanger, Ann. Rev. Biochem. **45**, 267-283 (1976).
2. M.Irie and K.Hayashi, Adv. Polym. Sci. , in press.

3. G.Smets, Adv. Polym. Sci. **50**, 17-44 (1983).
4. L.Matejka, M. Ilavsky, K.Dusek and O.Wichterle, Polymer **22**, 1511-1515 (1981).
5. F.Ciardelli, M.Aglietto, C.Carlini, E.Chiellini and R.Solaro, Pure Appl. Chem. **54**, 521-532 (1982).
6. A.Altomare, C.Carlini and R.Solaro, Polymer **23**, 1355-1360 (1982).
7. C.Bertucci, C.Carlini, R.Solaro, A.Altomare and M.Panattoni, Chim. Ind. (Milan) **64**, 604 (1982).
8. A.Altomare, C.Carlini, F.Ciardelli, N.Rosato and R.Solaro, J. Polym. Sci., Polym. Chem. Ed., in press.
9. H.H.Jaffe and M.Orchin, "Theory and Application of Ultraviolet Spectroscopy", Wiley, New York, 1962.
10. I.Tinoco, Jr., J. Am. Chem. Soc. **82**, 4785-4790 (1960).
11. K.Okamoto, A.Itaya and S.Kusabayashi, Chem. Lett., 1167-1172 (1974).
12. A.Altomare, C.Carlini, F.Ciardelli, R.Solaro, J.L.Houben and N.Rosato, Polymer **24**, 95-100 (1983).
13. H.Yuki and K.Ohta, ACS Polym. Prepr. **20**, 747-757 (1979).
14. C.Bertucci, C.Carlini, F.Ciardelli, C.Rosini and P.Salvadori, Polym. Bull. **5**, 535-542 (1981).
15. R.W.Woody, J. Polym. Sci.: Macromol. Rev. **12**, 181-321 (1977).
16. M.Goodman and M.L.Falxa, J. Am. Chem. Soc. **89**, 3863-3867 (1967).
17. A.Ueno, J.Anzai, T.Osa, Y.Kadoma, J. Polym. Sci.: Polym. Lett. Ed. **15**, 407-410 (1977).
18. A.Ueno, J.Anzai, T.Osa, Y.Kadoma, Bull. Chem. Soc. Japan **50**, 2995-2999 (1977).
19. A.Ueno, J.Anzai, T.Osa, Y.Kadoma, Bull. Chem. Soc. Japan **52**, 549-554 (1979).
20. A.Ueno, K.Takahashi, J.Anzai and T.Osa, Macromolecules **13**, 459-460 (1980).
21. A.Ueno, K.Takahashi, J.Anzai and T.Osa, J. Am. Chem. Soc. **103**, 6410-6415 (1981).
22. J.L.Houben, O.Pieroni, A.Fissi and F.Ciardelli, Biopolymers **17**, 799-804 (1978).
23. O.Pieroni, J.L.Houben, A.Fissi, P.Costantino and F.Ciardelli, J. Am. Chem. Soc. **102**, 5913-5915 (1980).
24. A.Fissi, J.L.Houben, N.Rosato, L.Lopes, O.Pieroni and F.Ciardelli, Makromol. Chem., Rapid Commun. **3**, 29-33 (1982).
25. J.L.Houben, A.Fissi, D.Bacciola, N.Rosato, O.Pieroni and F.Ciardelli, Int. J. Biol. Macromol. **5**, 94-100 (1983).
26. W.Koning and R.Geiger, Chem. Ber. **106**, 3626-3635 (1973).
27. V.Saudek, H.Pivkova and J.Drobnik, Biopolymers **20**, 1615-1623 (1981).
28. W.H.Welch, Jr. and G.D.Fasman, Biochemistry **13**, 2455-2466 (1974).
29. M.N.Jones, C.P.Patrick and M.C.Phillips, J. Colloid Interface Sci. **55**, 116-125 (1976).
30. E.Peggion, A.S.Verdini, A.Cosani and E.Scoffone, Macromolecules **3**, 194-198 (1970).
31. G.Seipke, H.A.Arffmann and K.G.Wagner, Biopolymers **19**, 189-201 (1980).
32. E.Iizuka and J.T.Yang, Biochemistry **4**, 1249-1257 (1965).
33. J.W.Longworth, J.J.ten Bosch, J.A.Knopp and R.O.Rahn, in "Molecular Luminescence", E.Lim. Ed., Benjamin, New York, p. 529 (1979).
34. B.Brocklehurst, D.C.Bull, M.Evans and P.M.Scott, J. Am. Chem. Soc. **97**, 2977-2985 (1975).
35. C.G.Sridhar, W.A.Hines, E.T.Samulski, J. Chem. Phys. **61**, 947-958 (1974).
36. H.Hayashi, A.Wada, Biopolymers **20**, 695-705 (1981).
37. G.Van der Veen and W.Prins, Photochem. Photobiol. **19**, 191-204 (1974).
38. J.S.Tan and R.L.Schneider, J. Phys. Chem. **79**, 1380-1386 (1975).
39. F.Ciardelli, C.Carlini, E.Chiellini, P.Salvadori, L.Lardicci and O.Pieroni, Proc. 5th European Symposium on Polymer Spectroscopy, D.O.Hummel Ed., Verlag Chemie, Weinheim, p. 131-216 (1979).
40. J.Estevez and M.H.Loucheux-Lefebvre, Biopolymers **15**, 2101-2119 (1976).
41. H.Nomori, N.Tsuchihashi, S.Takagi and M.Hatano, Bull. Chem. Soc. Japan **48**, 2522-2526 (1975).
42. G.Montagnoli, O.Pieroni and S.Suzuki, Polym. Photochem. **3**, 279-294 (1983).