

## Organocuprate addition to $\alpha, \beta$ -unsaturated compounds: synthetic and mechanistic aspects

Christina Ullenius and Beritte Christenson

Department of Organic Chemistry, Chalmers University of Technology,  
 S-412 96 Göteborg, Sweden

**Abstract** - A mechanistic model for the addition of lithium dimethylcuprate to enoates and enones is proposed on the basis of chemical and NMR-spectroscopic studies. The first step of the reaction is the reversible formation of a copper(I)-alkene  $\pi$ -complex by coordination of the C=C group to one of the copper atoms in the dimeric cluster structure  $(Me_2CuLi)_2$ . The following steps lead to the irreversible formation of the new carbon-carbon bond. With chiral substrates two diastereomeric  $\pi$ -complexes are postulated, the stereoselectivity being determined by the relative rates for their irreversible decay. In the reaction between methyl *S*-ortho-dimethylaminoethylcinnamate, **10**, and lithium dimethyl- and lithium diphenylcuprate the diastereomeric product ratios are ca 5:1.

### INTRODUCTION

Conjugate addition of lithium diorganocuprates,  $R_2CuLi$ , to Michael type acceptors, *eg.* enones and enoates, is a valuable tool in organic synthesis, a particularly useful feature of the reaction being the high stereoselectivity which often can be obtained. The vast area of organocopper compounds in organic synthesis has been reviewed (*ref.* 1) several times since the early 1970s and has been the subject of a book (*ref.* 2).

Our attempts at asymmetric synthesis using chiral mixed cuprates in conjugate additions (*ref.* 3) have stimulated our interest in the detailed mechanism of these reactions.

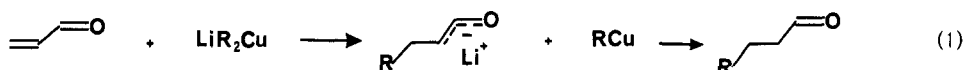

The problem has been addressed by several groups and different mechanistic schemes have been presented. House (*ref.* 4) has suggested that after initial coordination to the carbonyl oxygen the conjugate addition starts by a single electron transfer (SET) from the cuprate to the substrate enone, followed by copper-carbon bond formation to give copper(III) intermediate, which after carbon-carbon bond formation gives the lithium enolate as the observable product of the reaction, *cf.* Scheme 1. An alternative route to a copper(III) intermediate via electron transfer within a charge transfer complex has been proposed by Smith and Hannah (*ref.* 5), *cf.* Scheme 1.

Scheme 1

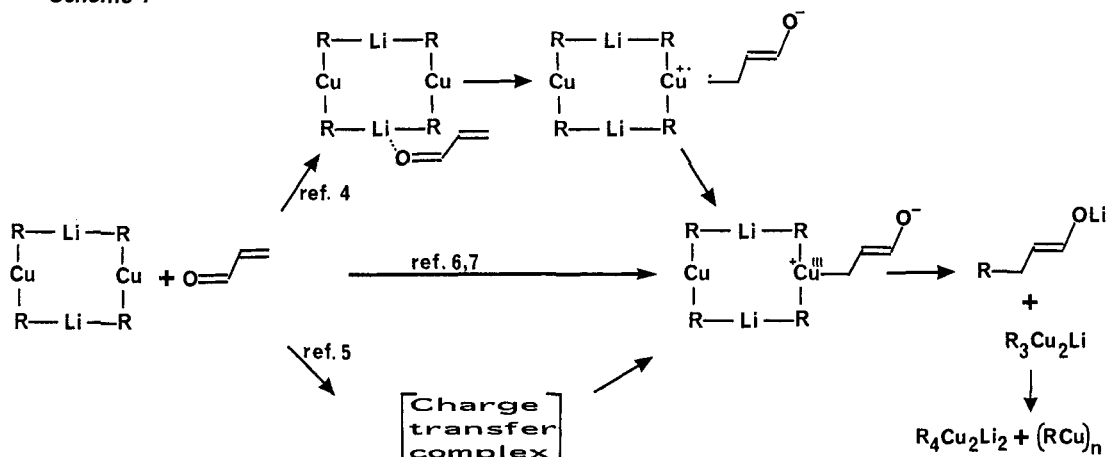

However, objections have been raised to the single electron transfer as an early step in the conjugate addition, and the reaction can also be thought to proceed by a nucleophilic addition mechanism (ref. 6). Both mechanisms are viewed as proceeding via an oxidative addition to give a Cu(III) adduct which subsequently undergoes reductive elimination to the observed enolate, cf. Scheme 1. Results obtained by Casey (ref. 7) have been interpreted in terms of a direct nucleophilic attack of cuprate on the substrate.

Based on studies of the addition of organic cuprates to allenes substituted with electron withdrawing groups, Berlan (ref. 8) has proposed a mechanism related to the classical organometallic insertion reaction or carbometalation. The cuprate carbon-copper bond adds across the alkene group forming an  $\alpha$ -cuprioketone which is rearranged to the thermodynamically more stable lithium enolate, Scheme 2. The mechanism proposed in ref. 8a includes a hypothetical copper(I)-alkene  $\pi$ -complex.

Scheme 2

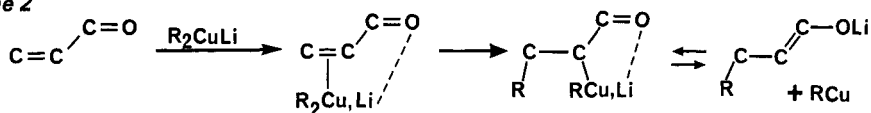

Based on a kinetic study Krauss and Smith (ref. 9) propose a mechanism in which the reactants are in equilibrium with an intermediate complex, which may unimolecularly rearrange to form a trialkylcopper(III) species with copper bonded to the  $\beta$ -carbon of the lithium enolate, followed by reductive elimination. It was proposed that the initial complex is formed by lithium coordination to the carbonyl oxygen.

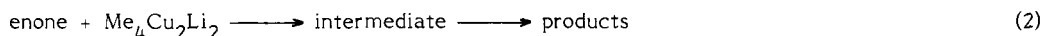

In an effort to resolve the above mentioned mechanistic differences, we have studied the conjugate addition of lithium diorganocuprates to enones and enoates by NMR spectroscopy and have also investigated the effect of coordination by solvent or coordinating groups in the reactants. Our major goal has been to improve the prospects for rational design of asymmetric synthesis using organocuprates.

### NMR INVESTIGATIONS

The reaction between methyl cinnamate, **1**, and lithium dimethylcuprate,  $\text{Me}_2\text{CuLi}$ , was studied by  $^{13}\text{C}$  and  $^1\text{H}$  NMR spectroscopy in the temperature range  $-110^\circ$  to  $+60^\circ\text{C}$  (ref. 10). The notation  $\text{Me}_2\text{CuLi}$  is used for simplicity without any structural implications. Two different solvent systems were used, diethyl ether/dichloromethane- $d_2$  and tetrahydrofuran/toluene- $d_8$ .

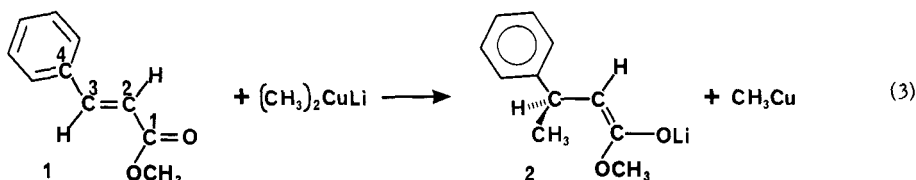

In the  $^{13}\text{C}$  NMR spectra at low temperatures, below  $-50^\circ\text{C}$ , the olefinic carbon C2 and C3 signals are found shifted strongly upfield, cf. Table 1. The signals assigned to C2 and C3 were observed as doublets,  $J_{\text{C-H}} = 160$  Hz.

The observed upfield shifts of carbons C2 and C3 are of the order of magnitude typical for coordination shifts for trigonal alkene-transition metal complexes. The coordination shifts for some Ni, Pd, and Pt complexes are reported to be approximately  $-60$  ppm (ref. 11). We have interpreted the strong upfield shift of C2 and C3 as being due to bond formation between the enoate C=C bond and copper in  $\text{Me}_2\text{CuLi}$  giving a copper-alkene  $\pi$ -complex and thus found experimental evidence for the intermediate proposed by Berlan (ref. 8a). The stronger coordination shift of the enoate  $\beta$ -carbon

TABLE 1.  $^{13}\text{C}$  NMR chemical shift data ( $\delta$  rel. to TMS) for methyl cinnamate, **1**, and  $\text{Me}_2\text{CuLi}$  in  $\text{Et}_2\text{O}/\text{CD}_2\text{Cl}_2$ .

System	C1	C2	C2	C3	C3	C4	Temp $^\circ\text{C}$
<b>1</b>	167.6	118.4		145.0		135.0	-60
1+LiI	170.3	117.3	-1.1	147.7	+2.7	134.7	
1+ $\text{Me}_2\text{CuLi}$	173.3	62	-55	74.6	-73.1	139.4	-70
enolate <b>2</b>	161.8	73.8		36.5		150.1	0

probably indicates a change in delocalisation in the cinnamate  $\pi$ -system. When the solvent system is changed from diethyl ether/methylene chloride to THF/toluene the signals for C2 and C3 are shifted even further upfield, the coordination shifts being C2 -65.7 ppm and C3 -83.1 ppm respectively. The larger coordination shifts indicate a higher electron density around copper when THF is present. When the reaction mixture containing the  $\pi$ -complex was warmed to temperatures above  $-50^{\circ}\text{C}$  the product enolate, **2**, was formed irreversibly, Table 1.

The shift changes observed on addition of  $\text{Me}_2\text{CuLi}$  to methyl cinnamate are less likely to be caused by lithium coordination to the C=C bond or the carbonyl oxygen. LiI was added to methyl cinnamate in a separate experiment, *cf.* Table 1, and only minor chemical shift changes were observed.

$^1\text{H}$  NMR spectra of solutions of  $\text{Me}_2\text{CuLi}$  and methyl cinnamate show the olefinic proton signals shifted strongly upfield, H2 from  $\delta$  6.55 to 4.3 and H3 from 7.73 to 4.6 in **1**, confirming the formation of a copper-alkene  $\pi$ -complex. Dynamic NMR experiments in the temperature region  $-110^{\circ}\text{C}$  to  $+60^{\circ}\text{C}$  show that there is an equilibrium between the reactants and the copper-alkene  $\pi$ -complex. Signals due to the  $\pi$ -complex, the cuprate and methyl cinnamate can be observed separately at temperatures below  $-70^{\circ}\text{C}$ . Between  $-50^{\circ}\text{C}$  and  $-70^{\circ}\text{C}$  coalescence of the olefinic proton signals occurs but relowering of the temperature regenerates the original spectrum. Above  $-50^{\circ}\text{C}$  the irreversible conjugate addition occurs giving rise to signals due to the product enolate, **2**.

On the basis of our NMR data we suggest the formation of a copper-alkene  $\pi$ -complex to be the first step in the conjugate addition, Scheme 3. We also propose that the reversible formation of a  $\pi$ -complex and its unimolecular decay to an enolate are the reactions studied by Krauss and Smith (*ref.* 9). A lithium-oxygen interaction within the  $\pi$ -complex is likely but can be neither confirmed nor disproved on the basis of our data.

Previous to the present investigation, few copper-alkene complexes from alkenes with electron withdrawing substituents had been isolated and characterized. Kochi *et al* (*ref.* 12) had reported a series of complexes formed between copper triflate and cyclic alkenes with isolated C=C bonds. The  $^1\text{H}$  and  $^{13}\text{C}$  NMR coordination chemical shifts reported for these alkene-copper cations are substantially smaller than those we have observed.

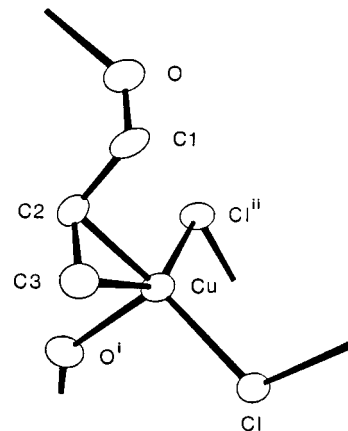
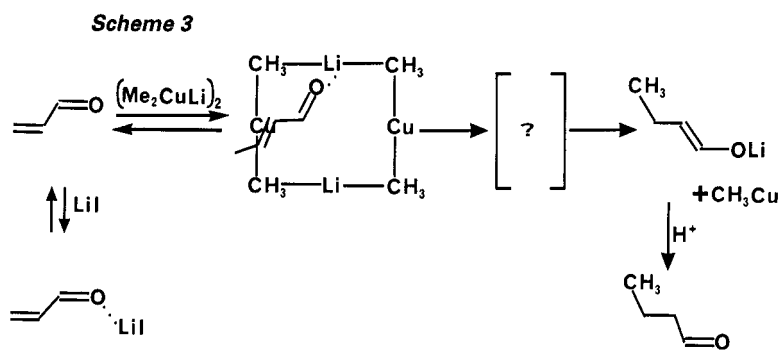

Figure 1.

Part of the  $\text{CuCl}(\text{C}_3\text{H}_4\text{O})$  polymer. Hydrogen atoms have been omitted.

## PREPARATION AND STRUCTURE OF $\text{CuCl}$ -ENONE $\pi$ -COMPLEXES

The synthesis of some coordination compounds from copper(I) chloride and simple enones was undertaken to verify the formation of unstable  $\pi$ -complexes between copper(I) and carbonyl substituted alkenes. Copper(I) chloride was mixed with propenal (*ref.* 13a), butenone (*ref.* 13b) and 1-pentene-3-one (*ref.* 13c) under an inert atmosphere. The corresponding copper-alkene  $\pi$ -complexes, obtained as highly labile solids which decompose on exposure to air, were investigated by single crystal X-ray diffraction. The propenal -  $\text{CuCl}$  complex has a polymeric structure, Fig. 1, with adjacent copper(I) atoms being bridged by propenal and chloride ligands to form a three-dimensional network.

Copper is situated 1.967 Å distant from the midpoint X of the C=C bond. The copper-carbon coordination distances are Cu-C2: 2.088 Å and C3: 2.075 Å (*ref.* 13a) and agree well with values determined previously for  $\pi$ -complexes between copper(I) and isolated alkenes (*ref.* 13a and references cited therein). The C=C, C-C and C=O bond lengths in coordinated propenal do not differ significantly from values obtained for *s-trans*-propenal itself (*ref.* 14).

The propenal coordinates another copper through the carbonyl oxygen, presumably via a lone-pair donation. However, the connectivity relationships within the bridging propenal molecule suggest that both the alkene-copper(I) and the oxygen-copper(I) interactions are relatively weak and the copper(I) alkene bonding is probably mainly an alkene-to-copper donation. Back-donation from copper d-orbitals to the alkene  $\pi^*$ -orbital would be expected to manifest itself in lengthening of the C=C bond.

### OBSERVATIONS OF COPPER-ENONE $\pi$ -COMPLEXES

Corey and Boaz have discussed the initial step of the conjugate addition in terms of d-orbital stereoelectronic control, i.e. interactions between diffuse filled copper(I) d-orbitals and an enone  $\Psi_3^*$ orbital (ref. 15). These workers have been able to isolate a yellow precipitate from the reaction (diethyl ether,  $-78^\circ\text{C}$ ) between  $\text{Me}_2\text{CuLi}$  and a spiro enone carrying a  $\gamma$ -oxygen (ref. 16). The isolated complex afforded stereoisomeric conjugate addition products when suspended in diethyl ether or partially dissolved in THF in the presence of trimethylsilyl chloride. This is thought to be the first case in which a cuprate-enone  $\pi$ -complex has been isolated and shown to be convertible to conjugate addition products (ref. 16).

So far, copper-alkene coordination has been discussed without considering the cuprate structure. We use the dimeric structure proposed for  $\text{Me}_2\text{CuLi}$  in diethyl ether on the basis of molecular weight determinations (ref. 17) although it is not clear whether this is also the reacting species.

### EFFECTS OF LIGAND COORDINATION ON CONJUGATE ADDITION

Diethyl ether and tetrahydrofuran, THF, are the most commonly used solvents for conjugate additions of cuprates to enones and enoates. Previous observations suggest that the presence of good donor solvents or donor ligands may be deleterious (ref. 18 and work cited therein). We have studied the efficiency of the conjugate addition of  $\text{Me}_2\text{CuLi}$  to E-4-phenyl-3-buten-2-one, **3**, in different solvents (ref. 19). Our results are summarized in Table 2.

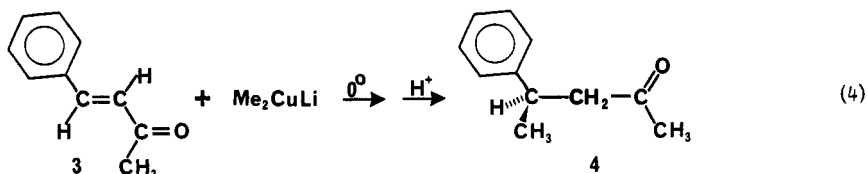

The high reactivity observed for the reactions performed in hexane, toluene and dichloromethane is remarkable considering that the cuprate is only moderately soluble in these solvents. A large part of  $\text{Me}_2\text{CuLi}$  is present as a suspension. A few equivalents of coordinated diethyl ether remain in the cuprate from its preparation and can not be removed even after extensive pumping (ref. 20). The amount of diethyl ether present can be monitored by NMR spectroscopy and is found to correlate with coordination of one or two diethyl ether molecules per  $\text{Me}_2\text{CuLi}$  unit.

Our chemical data in Table 2 together with NMR data imply that in diethyl ether, hydrocarbon solvents and in dichloromethane the same reactive species is taking part in conjugate addition while in good donor solvents like THF, acetonitrile or pyridine different species may be active. We propose that the reactive species in the fast reactions is  $\text{Me}_2\text{CuLi}$  coordinated by one or two diethylether molecules to each lithium, assuming that lithium is the electrophilic part of the cuprate.

Lipshutz and coworkers have compared the  $^7\text{Li}$  and  $^1\text{H}$  NMR spectra of  $\text{Me}_2\text{CuLi}$  in diethyl ether, diethyl ether/THF and THF solutions, respectively (ref. 21). They found that the choice of solvent for the preparation of the cuprate has a strong influence on what kind of species are formed. In diethyl ether a single species is obtained,  $(\text{Me}_2\text{CuLi})_2$ , while preparation in THF gives a mixture of three species;  $(\text{Me}_2\text{CuLi})_2$  in equilibrium with  $\text{MeLi}$  and  $\text{Me}_3\text{Cu}_2\text{Li}$ . Addition of THF to a solution of  $\text{Me}_2\text{CuLi}$  in diethyl ether does not give rise to the equilibrium characteristic of the cuprate that has been prepared in THF. Instead, a single species with a slight change in chemical shift is obtained after addition of THF. These observations corroborate our suggestion that dimeric  $\text{Me}_2\text{CuLi}(\text{ether})_n$  is the reacting species in hydrocarbon solvents or dichloromethane while good donor solvents induce a change in structure. However, the formation of highly reactive species in very low concentrations (and thus not observable by NMR) can not be ruled out.

To gain some further insight into the role of the solvent and the effect of coordination to the cuprate during the conjugate addition we have studied the reaction of  $\text{Me}_2\text{CuLi}$  with methyl cinnamates, **5a-f**, having built-in ligands in the ortho-position of the benzene ring. The methylthiomethyl, **5d**, dimethylaminomethyl, **5e**, and the methoxymethyl, **5f**, groups were chosen to test S, N and O as coordinating atoms isolated from the delocalized  $\pi$ -electron system by a methylene group. A methoxy group, **5c**, was included as a probe for "purely" electronic effects while the iso-propyl group, **5b**, was studied to get a measure of the steric effect of an ortho-substituent on the rate of the conjugate addition. The reactions were quenched after 5 min in order to use the yield of the products, **6a-f**, as a fair measure of the relative reactivities of the substrates **5a-f**, (ref. 22, 3a). The results are summarized in Table 3.

TABLE 2. Yield of 4-phenyl-2-pentanone, **4**, from the addition of  $\text{Me}_2\text{CuLi}$  to  $\underline{\text{E}}$ -4-phenyl-3-buten-2-one at  $0^\circ\text{C}$ . Reactant ratio 2:1.

Solvent	Yield of <b>4</b>	Chemical shift for $\text{Me}_2\text{CuLi}$	
		$\delta$ $^1\text{H}$	$\delta$ $^{13}\text{C}$
Hexane	>98%*		
Toluene	>98%		
Diethyl ether	>98%	-1.11	-9.6
Dichloromethane	>98%	-0.96	-8.7
-----			
Tetrahydrofuran	90%**		
Acetonitrile	54%		
Pyridine	28%	0.13	-8.5

\* within 1 min at  $0^\circ$ \*\* after 60 min at  $0^\circ$ TABLE 3. Yield of products **6a-f** after 5 min of reaction between  $\text{Me}_2\text{CuLi}$  and ortho-substituted methyl cinnamates **5a-f**.

5	Yield of <b>6</b> , % after min		$E_{1/2}$ V
	$0^\circ$	$-20^\circ$	
a, -H	18	2	-1.81 (ref. 4b)
b, $-\text{CH}(\text{CH}_3)_2$	10		
c, $-\text{OCH}_3$	10		-1.83
d, $-\text{CH}_2\text{SCH}_3$	15		
e, $-\text{CH}_2\text{N}(\text{CH}_3)_2$	27		
f, $-\text{CH}_2\text{OCH}_3$	>98	20	-1.79

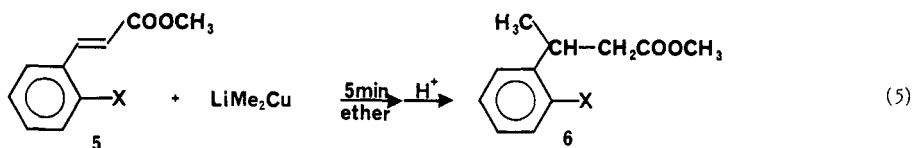

Comparison of **5a** and **5b** shows that the introduction of a bulky ortho-substituent has only a limited effect on the reactivity of the product. The higher reactivity exhibited by the dimethylaminomethyl, **5e**, and the methoxymethyl, **5f**, cinnamates is attributed to the ability to coordinate the built-in ligand to lithium in the cuprate. The difference in  $E_{1/2}$  values is small and assumed to be insignificant since **5a**, **5b**, **5e** and **5f** should be electrochemically similar.

We suggest that the rate enhancement observed for **5f** is the result of coordination of the methoxymethyl oxygen to the cuprate in the transition state thus lowering the activation energy. The methoxymethylcinnamate **5f** can be considered as a tridentate ligand for a dimeric  $\text{Me}_2\text{CuLi}$  species; in addition to bonding of copper(I) to the enoate  $\text{C}=\text{C}$  bond, coordination of the carbonyl oxygen and the methoxymethyl oxygen to two lithium atoms in the cuprate results in a three point-interaction. Structurally and electronically the methoxymethyl group resembles diethyl ether and can thus displace diethyl ether from coordination sites on  $(\text{Me}_2\text{CuLi})_2$  without causing structural changes in the cuprate. We propose that the dimeric cluster structure of the cuprate is essential for fast conjugate addition to take place.

The planar dimeric cluster structure proposed for  $\text{Me}_2\text{CuLi}$  in solution (ref. 17) has been corroborated by the first determination of the crystal structure of a cuprate by van Koten *et al.* (ref. 23), *cf.* Fig. 2.

The cuprate seems to be made up of two near-linear  $\text{R}_2\text{Cu}$  units held together by two lithium atoms to give an almost planar  $\text{Cu}_2\text{Li}_2$  arrangement. The dimethylaminomethyl groups serve as "intramolecular solvent molecules" (ref. 23) coordinating lithium. The Li-C bond is substantially longer than the Cu-C bond.

A theoretical treatment of  $\text{Me}_2\text{CuLi}$  by Whangbo (ref. 24) using molecular orbital calculations gives a square-planar configuration for  $(\text{Me}_2\text{CuLi})_2$  as depicted in Fig. 3. The major structural feature is the linear arrangement of methyl groups at copper.

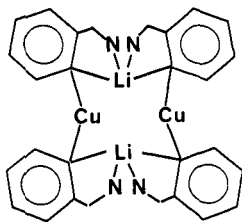
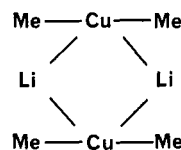
Fig. 2 Schematic structure of  $(\text{C}_6\text{H}_4\text{CH}_2\text{NMe}_2-2)_4\text{Cu}_2\text{Li}_2$ .Fig. 3. Calculated structure for  $\text{Me}_4\text{Cu}_2\text{Li}_2$ .

On the basis of our results, together with the structural information above, we suggest that the observed effect of donor solvents and ligands is due to coordination to lithium in the dimeric cuprate obtained in diethyl ether. Better Lewis bases increase the electron density on lithium and weaken the attraction to the  $\text{Me}_2\text{Cu}^-$  group, thus increasing the Li-C distance, *cf.* the chemical shift

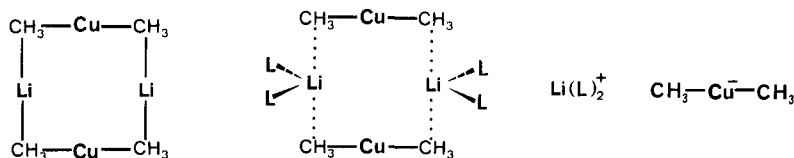

changes observed when exchanging diethyl ether for THF as a solvent for NMR experiments (ref. 10). Strongly coordinating ligands will cause the disruption of the cluster structure by formation of ligand-separated ion pairs.

Such an event can be observed by addition of 12-crown-4 to  $\text{Me}_2\text{CuLi}$  in diethyl ether, affording a white precipitate of the ion pair (ref. 25) which is unreactive towards enones. The crystal structure of this ion pair has been determined and shown to consist of well-separated cations,  $(\text{Li}(12\text{-crown-4})_2)^+$  and linear anions  $\text{Me}_2\text{Cu}^-$  (ref. 26.).

The coordination of built-in ligands to the cuprate is further demonstrated by the result obtained from attempts to add lithium dimethylcuprate (free from lithium iodide) to a methyl cinnamate carrying a polyether side chain in the *ortho*-position, **7**. After 2 hours at  $0^\circ\text{C}$  the conjugate addition product **8** was obtained in only 20% yield. Remaining **7** precipitated as an ion pair **9** and was thus withdrawn from further reaction (ref. 22).

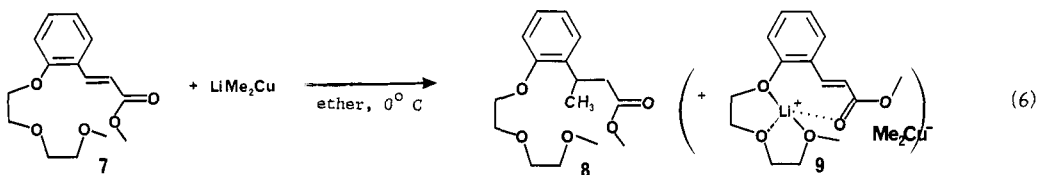

Intramolecular assistance from built-in ligands has also been observed by Normant, Alexakis *et al.* (ref. 27). They have shown that the regioselectivity of the *syn*-addition of alkylcopper compounds to alkynes carrying heteroatoms along the carbon chain is dependant on the nature of the coordinating group and on the solvent.

### COPPER-ALKENE $\pi$ -COMPLEX AS A TRANSITION STATE MODEL

The copper(I)-alkene  $\pi$ -complex observed by NMR in the reactions of methyl cinnamate with  $\text{Me}_2\text{CuLi}$  now can be discussed in more detail, adopting the square-planar dimeric structure for the cuprate. The enoate should be oriented to allow efficient bonding of the C=C bond to copper while the carbonyl oxygen is oriented towards lithium displacing one diethyl ether molecule from the coordination sphere. Enoates with built-in ligands, **5c-f**, can direct the heteroatom towards the second lithium atom.

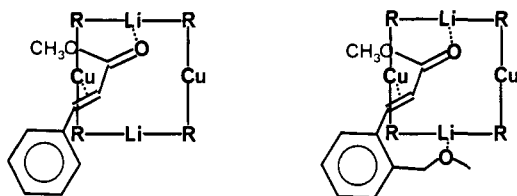

The next step of the reaction can be either the carbocupriation step suggested by Berlan (ref. 8) or the formation of the  $\beta$ -carbon-copper(III) intermediate (ref. 4, 5, 7, 9). The configuration at the  $\beta$ -carbon after carbon-carbon bond formation will be determined by the geometry of the  $\pi$ -complex. With chiral starting materials two diastereomeric  $\pi$ -complexes should thus be formed. The stereo-selectivity of the reaction will then depend on the relative rates of the reaction of these  $\pi$ -complexes in the irreversible formation of the new carbon-carbon bond.

The feasibility of the copper(I)-alkene  $\pi$ -complex as a reasonable transition-state model can also be investigated by molecular orbital calculations. Extended Hückel calculations on a model system suggest an interesting structure for the  $\pi$ -complex (ref. 28). Cinnamaldehyde was used as a model enone system and was allowed to approach a dimeric square-planar cuprate structure from "above" starting from a distance of 3.3 Å between one copper and the midpoint X of the C=C bond. An optimized structure is obtained with a copper-X distance of ca 2.1 Å. Geometrical changes within the enone as well as within the cuprate are worthy of notice (Fig. 4).

A significant lengthening of the C=C and C=O bonds occurs together with a shortening of the C-C bond in the enone. The cuprate is no longer symmetrical as the Cu-C bonds of the coordinated copper atom are unequal in length, 2.1 and 4.6 Å respectively. The other copper atom is bent out of the plane towards the carbonyl oxygen, allowing for coordination of the carbonyl oxygen to both copper and lithium!

The connectivity changes in the cinnamaldehyde suggest some  $\psi_3^*$  character in the delocalized electron system. This observation together with the large  $^{13}\text{C}$  coordination shifts observed by NMR indicate that the bonding interaction in the  $\pi$ -complex is not only an alkene-to-copper donation (filled enone  $\psi_2$  to vacant copper 4s and 4p) but also some back donation from a filled copper d-orbital to the  $\psi_3^*$  enone LUMO. The effect of the back donation is probably relatively small but decidedly more efficient from a  $\text{Me}_2\text{Cu}$  unit with high electron density on copper relative to copper in copper(I) chloride (ref. 13) or copper cations in copper(I) triflate (ref. 12).

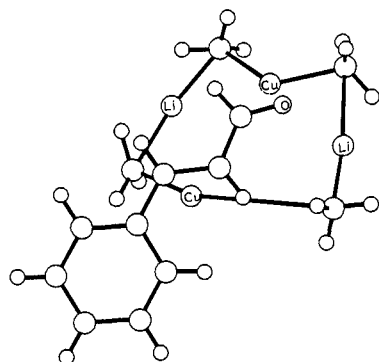
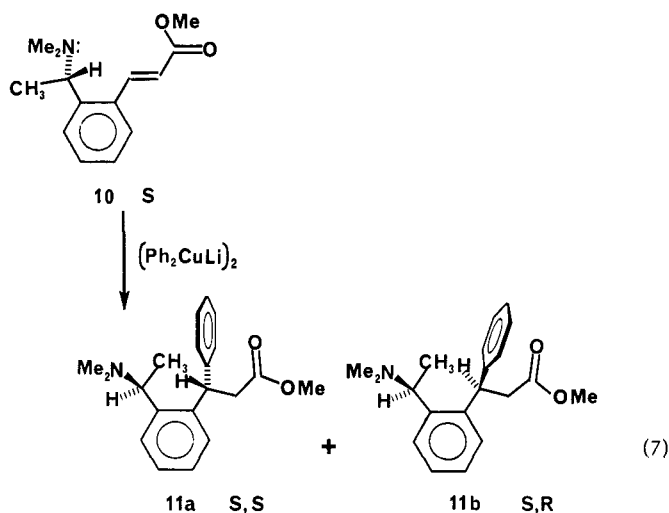

Fig. 4 Schematic structure for a hypothetical  $\pi$ -complex from cinnamaldehyde and lithium dimethylcuprate, according to EHT calculations.



## DIASTEREOSELECTIVE CONJUGATE ADDITIONS

Several examples of good stereoselectivity in cuprate additions to enones possessing  $\gamma$ -oxygen or amide nitrogen substituents have been reported (ref. 29). Some of these have been interpreted as occurring in an anti sense relative to the heteroatom at  $C_\gamma$ . However, Fuchs *et al.* (ref. 30) have demonstrated high stereoselectivity in the amine-directed cis-addition of cuprates to dimethylamino-substituted cyclopentyl sulfones.

We are presently trying to utilize the effect of built-in ligands on diastereoselective synthesis starting with chiral substituents in the methyl cinnamate. Methyl S-ortho-dimethylaminoethylcinnamate, **10**, has been reacted with lithium dimethylcuprate, lithium diethylcuprate and lithium diphenylcuprate, respectively in diethyl ether. The addition products are formed in good yield. The diastereoselectivity varies slightly with the size of the R group of the cuprate, and with  $\text{Me}_2\text{CuLi}$  the diastereomers are formed in the relative ratio 4.5:1 (ref. 31). The selectivity can be improved by changing to dichloromethane as solvent for the reaction.

The diastereoisomers, **11**, obtained from reaction of **10** with lithium diphenylcuprate have been separated by HPLC and the major isomer has been assigned the S,S configuration based on comparisons of  $^1\text{H}$  NMR spectra of **11a** and **11b** with the spectrum of S,S-4-(2-(1-dimethylaminoethyl))phenyl-4-phenyl-2-butanone, **12**, (ref. 3b). The crystal structure of **12** has been determined by X-ray diffraction (ref. 32).

The formation of the S,S-diastereomer in cuprate additions to **10** is in good agreement with the proposed intramolecular coordination of the dimethylamino group to lithium within the copper(I)-alkene  $\pi$ -complex. Inspection of CPK molecular models gives support to this interpretation since in the least hindered conformation of the substrate **10** the dimethylamino group is best accommodated in a position favouring coordination to the cuprate.

The magnitude of the diastereoselectivity indicates that other factors are also important, *eg* steric hindrance. With as bulky side-chains on the enoate as in **5e**, **5f** and **10** we also observe side reactions unless the reaction conditions are carefully controlled.

## CONCLUSION

The formation of a copper(I)-alkene complex as an initial step of the conjugate addition of lithium diorganocuprates to enones and enoates has been demonstrated. The complex is stable at temperatures around  $-100^\circ\text{C}$ . On raising the temperature the  $\pi$ -complex irreversibly forms the expected enolate product from a conjugate addition reaction which may occur either via a carbocupration (ref. 8) or via the formation of a transient copper(III) intermediate (ref. 4-7, 9). The coordination

within the  $\pi$ -complex can be used to rationalize the effect of built-in ligands on the stereo-selectivity in the addition of cuprates to chiral substrates. A rationale for the effectiveness of diethyl ether and/or hydrocarbons as solvents for the reaction has also been obtained.

### Acknowledgement

Sincere thanks are extended to co-workers, past and present, who have taken part in this work. Valuable discussions with Dr. S. Jagner och Prof. M. Nilsson are gratefully acknowledged as is the financial support provided by the Swedish Natural Science Research Council and the National Swedish Board for Technical Development. Dr. David Tanner has kindly improved the English of the manuscript.

### REFERENCES

- For some recent reviews see a) R.J.K. Taylor, *Synthesis* 364-392 (1985), b) B.H. Lipshutz, R.S. Wilhelm and J.A. Kozlowski, *Tetrahedron* **40**, 5005-5038 (1984), c) J.F. Normant and A. Alexakis in *Current Trends in Organic Synthesis*, Pergamon Press, New York, pp 291-302 (1983), d) G. van Koten and J.G. Noltes, in *Comprehensive Organomet. Chem.* vol. 2, 709-763 (1982), e) W. Carruthers, in *Comprehensive Organometal. Chem.* vol 7, 661-729 (1982), f) Gmelin, *Organocopper compounds*, Springer, part 1 (1985), part 2 (1983), part 3 (1986).
- G.H. Posner, *An Introduction to Synthesis using Organocopper reagents*, Wiley, New York, 1980.
- a) B. Christenson, G. Hallnemo and C. Ullenius, *Chemica Scripta*, in press, b) H. Malmberg, M. Nilsson and C. Ullenius, *Tetrahedron Letters*, **23**, 3823-3826 (1982), c) B. Gustafsson, G. Hallnemo and C. Ullenius, *Acta Chem. Scand.* **B34**, 443-445 (1980), d) B. Gustafsson, A.-T. Hansson and C. Ullenius, *Acta Chem. Scand.* **B34**, 113-117 (1980).
- a) H.O. House, *Acc. Chem. Res.* **9**, 59-67 (1976), b) H.O. House and M.J. Umen, *J. Org. Chem.* **38**, 3893-3901 (1973), c) H.O. House and M.J. Umen *J. Am. Chem. Soc.* **94**, 5495-5497 (1972).
- R.A.J. Smith and D.J. Hannah, *Tetrahedron* **35**, 1183-1189 (1979).
- C.R. Johnson and G.A. Dutra, *J. Am. Chem. Soc.* **95**, 7777-7783, 7783-7788 (1973).
- C.P. Casey and M.C. Cesa, *J. Am. Chem. Soc.* **101** 4236-4244 (1979).
- a) J. Berlan, J.-P. Battioni and K. Koosha, *Bull. Soc. Chim. France*, **II**, 183-190 (1979), b) J. Berlan, K. Koosha and J.-P. Battioni, *Bull. Soc. Chim. France*, **II**, 575-580 (1978), c) J. Berlan and K. Koosha, *J. Organometal. Chem.* **153**, 99-106, 107-113 (1978), d) J. Berlan, J.-P. Battioni and K. Koosha, *J. Organometal. Chem.* **152**, 359-365 (1978), e) J. Berlan, J.-P. Battioni and K. Koosha, *Tetrahedron Letters* **3355-3358** (1976).
- S.R. Krauss and S.G. Smith, *J. Am. Chem. Soc.* **103**, 141-148 (1981).
- a) G. Hallnemo, T. Olsson and C. Ullenius, *J. Organometal. Chem.* **265**, C22-C24 (1984), b) G. Hallnemo, T. Olsson and C. Ullenius, *J. Organometal. Chem.* **282**, 133-144 (1985).
- P.W. Jolly and R. Mynott, *Adv. Organometal. Chem.* **19**, 257-304 (1981).
- R.G. Salomon and J.K. Kochi, *J. Organometal. Chem.* **64**, 135-143 (1974).
- a) S. Andersson, M. Håkansson, S. Jagner, M. Nilsson, C. Ullenius and F. Urso, *Acta Chem. Scand.* **A40**, 58-62 (1986), b) S. Andersson, M. Håkansson, S. Jagner, M. Nilsson and F. Urso, *Acta Chem. Scand.* **A40**, 194-199 (1986), c) S. Andersson, S. Jagner and M. Nilsson, *J. Organometal. Chem.* in press.
- R. Wagner, J. Fine, J.W. Simmons and J.H. Goldstein, *J. Chem. Phys.* **26**, 634-637 (1957).
- E.J. Corey and N.W. Boaz, *Tetrahedron Letters* **25**, 3063-3066 (1984).
- E.J. Corey and N.W. Boaz, *Tetrahedron Letters* **26**, 6015-6018 (1985).
- a) R.G. Pearson and C.D. Gregory, *J. Am. Chem. Soc.* **98**, 4098-4104 (1976), b) E.C. Ashby and J.J. Watkins, *J. Am. Chem. Soc.* **99**, 5312-5317 (1977).
- H.O. House and J.M. Wilkins, *J. Org. Chem.* **43**, 2443-2454 (1978).
- G. Hallnemo and C. Ullenius, *Tetrahedron* **39**, 1621-1625 (1983).
- V. Besace, J. Berlan, G. Pourcelot and M. Huche, *J. Organometal. Chem.* **247**, C11-C13 (1983).
- a) B.H. Lipshutz, J.A. Kozlowski and C.M. Breneman, *J. Am. Chem. Soc.* **107**, 3197-3204 (1985), b) B.H. Lipshutz, J.A. Kozlowski and C.M. Breneman, *Tetrahedron Letters* **26**, 5911-5914 (1985).
- G. Hallnemo and C. Ullenius, *Tetrahedron Letters* **27**, 395-398 (1986).
- G. van Koten, J.T.B.H. Jastrzebski, F. Muller and C.H. Stam, *J. Am. Chem. Soc.* **107**, 697-698 (1985).
- K.R. Stewart, J.R. Lever and M.-H. Whangbo, *J. Org. Chem.* **47**, 1472-1474 (1982).
- C. Ouannes, G. Dressaire and V. Langlois, *Tetrahedron Letters* **815-818** (1977).
- H. Hope, M.M. Olmstead, P.P. Power, J. Sandell and X. Xu, *J. Am. Chem. Soc.* **107**, 4337-4338 (1985).
- See for example: a) A. Alexakis, J. Normant and J. Villieras, *J. Organometal. Chem.* **96**, 471-485 (1975), b) A. Alexakis, J. Normant and J. Villieras, *J. Mol. Cat.* **I**, 43-58 (1975/76).
- B. Christenson, U. Norinder and C. Ullenius, to be published.
- a) J.K. Cha and S.C. Lewis, *Tetrahedron Letters* **25**, 5263-5266 (1984), b) W.R. Roush and B.M. Lesur, *Tetrahedron Letters* **24**, 2231-2234 (1983), c) R.G. Salomon, D.B. Miller, S.R. Raychaudhuri, K. Avasthi, K. Lal and B.S. Levison, *J. Am. Chem. Soc.* **106**, 8296-8298 (1984), d) K.C. Nicolaou, M.R. Pavia and S.P. Seitz, *J. Am. Chem. Soc.* **103**, 1224-1226 (1981).
- D.K. Hutchinson, S.A. Hardinger and P.L. Fuchs, *Tetrahedron Letters* **27**, 1425-1428 (1986).
- B. Christenson and C. Ullenius, to be published.
- S. Andersson, S. Jagner, M. Nilsson and F. Urso, *J. Organometal. Chem.* **301**, 257-267 (1986).